

THE EARLY ELECTRIFICATION OF ANCHORAGE

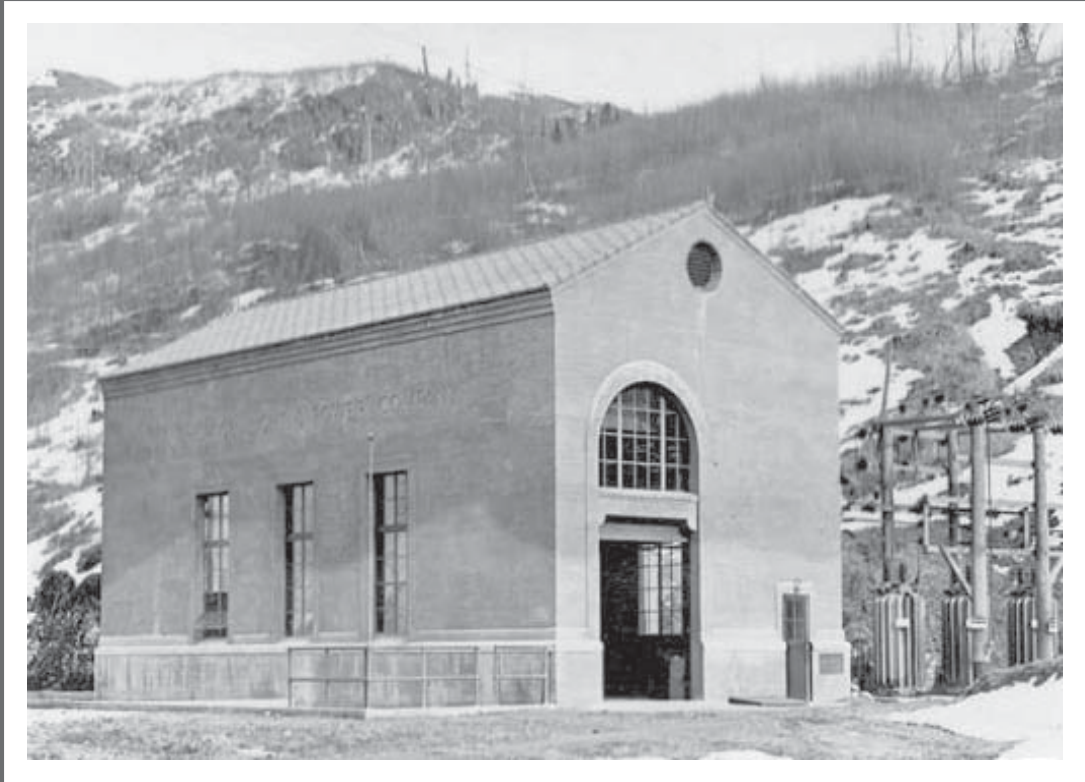

July 2002

CEMML TPS 02-8

THE EARLY ELECTRIFICATION OF ANCHORAGE



Kristy Hollinger

Edited by:

Glenda R. Lesondak

Prepared by:

Center for Environmental Management of Military Lands
Colorado State University
Ft. Collins, CO 80523-1500

Russell H. Sackett
Natural Resources Branch
U.S. Army Alaska
Fort Richardson, AK 99505-6500

July 2002

CEMML TPS 02-8

TABLE OF CONTENTS

CHAPTERS

1.0 INTRODUCTION	1
1.1 Acknowledgements	1
2.0 METHODOLOGY	3
3.0 ANCHORAGE AND EARLY ELECTRICITY	5
3.1 Anchorage Power	1
4.0 ENVIRONMENT	9
5.0 HYDROELECTRIC POWER	11
5.1 Technology	11
5.2 Hydroelectric Power in Alaska	12
6.0 EKLUTNA POWER PROJECT	15
6.1 Project Development 1920 –1928	15
6.2 Land Rights	21
6.3 Building of Transmission Line	23
6.4 Transportation and Construction Crews	25
6.5 Project Components	26
6.5.1 Tunnel	26
6.5.2 Diversion Dam	27
6.5.3 Storage Dam	28
6.5.4 Penstock	29
6.5.5 Powerhouse	30
6.5.6 Anchorage Substation	31
7.0 OPERATIONS	33
8.0 ANCHORAGE AND THE EKLUTNA POWER PLANT	41
9.0 EKLUTNA POWER PLANT IS SOLD TO THE CITY	43
9.1 Life at the Power Plant: 1943–1955	44
10.0 ANCHORAGE POWER NEEDS GROW	49
11.0 NATIONAL REGISTER OF HISTORIC PLACES	51
11.1 Physical Remains	51
11.2 Eligibility	53
11.3 Areas for Further Study	54
REFERENCES	55

LIST OF FIGURES

Cover Photograph: Old Eklutna Power Plant. From personal collection of Frank M. Reed Sr.

Figure 1. Frank M. Reed Sr. sitting next to Eklutna powerhouse plaque. Photo by Kristy Hollinger, 3 July, 2001.	1
Figure 2. Close-up of Eklutna powerhouse plaque. Photo by Kristy Hollinger, 3 July 2001.	2
Figure 3. AEC powerhouse. Courtesy of Anchorage Museum of History and Art, BL70-2-3411.	6
Figure 4. Eklutna Valley and Lake. Courtesy of Anchorage Museum History & Art, WWS 0107-R03.	9
Figure 5. Portrait of Frank I. Reed. From personal collection of Frank M. Reed Sr.	16
Figure 6. Example of standard pole. Reproduced from "AL&P Transmission Line Details," National Archives, Pacific Alaska Region, APA Historical Files and Photos Collection, 1948 –1998, Box 42.	23
Figure 7. Frank I. Reed standing at a pole on completed transmission line—December, 1928. From personal collection of Frank M. Reed Sr.	23
Figure 8. Photo by K. Hollinger 4 Sept. 2001.	24
Figure 9. Example of number plate on pole. From personal collection of Frank M. Reed Sr. Insulator.	24
Figure 10. View of construction camp at powerhouse site: tents center left. From personal Collection of Frank M. Reed Sr.	25
Figure 11. Diversion dam in canyon on Eklutna River. Courtesy of National Archives, Alaska Region, APA. Box 42.	27
Figure 12. Upstream face of diversion dam under construction. From personal collection of Frank M. Reed Sr.	27
Figure 13. Catwalk installed on diversion dam in 1933 at request of FPC. Courtesy of National Archives, AK Region, APA Box 42.	28
Figure 14. Eklutna Lake spillway discharging 1,500 cubic feet of water per second. July 7, 1929. From personal collection of Frank M. Reed Sr.	29
Figure 15. Penstock construction in background, behind powerhouse. RR spur in foreground removed after construction finished. From personal collection of Frank M. Reed Sr.	29
Figure 16. AL&P powerhouse as it appears with lean-to added in 1935—and the relocated transformers to left. Courtesy of National Archives, AK Region, APA Box 42.	30
Figure 17. Pelton Wheel, interior of powerhouse. From personal collection of Frank M. Reed Sr.	30
Figure 18. Transformer station adjacent to Eklutna power plant. Courtesy of National Archives, AK Region, APA Box 42.	31
Figure 19. Tailrace extending from rear of powerhouse. From personal collection of Frank M. Reed Sr.	31
Figure 20. Anchorage substation, 1929. From personal collection of Frank M. Reed Sr.	31
Figure 21. Powerhouse drawing, reproduced from National Archives, AK Region, APA, Box 42.	32
Figure 22: Anchorage Daily Times add, 14 September 1929.	36
Figure 23. Original AL&P office on 4th and E. Office moved to Masonic Building in 1932 or 33'. From personal collection of Frank M. Reed Sr.	37
Figure 24: General view of Eklutna Dam, Weir, Headgates & Breakwater. Courtesy of National Archives, Pacific AK Region, APA Historical Files and Photos Collection, Box 42.	38
Figure 25. Frank M. and Maxine Reed getting ready to move into their cottage at Eklutna, 1937, From personal collection of Frank M. Reed Sr.	39
Figure 26. Frank M. and Maxine Reed's cottage at Eklutna. Courtesy FMR.	40
Figure 27. Cottage interior. Courtesy FMR.	40
Figure 28. Anchorage Daily Times ad, 21 Sept. 1929.	41

Figure 28. Anchorage Daily Times ad, 21 Sept. 1929.....	41
Figure 29. Anchorage Daily Times ad, 21 Sept. 1929.....	42
Figure 30. Anchorage Daily Times ad, 21 Sept. 1929.....	42
Figure 31. Soldiers at diversion dam guard house during World War II. Courtesy of Mary Ada Peery.	44
Figure 32. Eklutna Lake storage dam and house that Shackleton family lived in. Courtesy of Mary Ada Peery.	45
Figure 33. Maintenance work at the diversion dam — tram in background. April, 1945. Courtesy of Ray Kozlowski.	46
Figure 34. Men working on diversion dam tram. April, 1945. Courtesy of Ray Kozlowski	46
Figure 35. Old cookhouse at Eklutna Camp. Courtesy of Mary Ada Peery.	47
Figure 36. Francis Lee in front of the new Turner house, which served as cookhouse and bunkhouse for boarders. Courtesy of Mary Ada Peery.	47
Figure 37. Jane (Shackleton) Lee in front of the Stevens house and two garages. Substation in background. Courtesy of Mary Ada Peery.	47
Figure 38. Francis, Mary Ada and Genie Lee in front of their house. Courtesy of Mary Ada Peery.	47
Figure 39. Left to right: Carmel Mohan (Tysver), Jimmy Lee, Mary Ada Lee (Peery) and unknown, in front of Francis and Genie Lee's house. Courtesy of Carmel Tysver.	48
Figure 40. Mary Ada Lee (Peery) with Jack and Jane Lee's son, Jimmy, in front of the Stevens house. Courtesy of Mary Ada Peery.	48
Figure 41. Francis and Genie Lee's house in winter. Courtesy of Mary Ada Peery.	48
Figure 42. Pole on Fort Richardson, photo by R. Sackett 2001.	51
Figure 43. Rear view of powerhouse — tailrace remains in foreground. Photo by R. Sackett 2001.	52
Figure 44. Front view of powerhouse as it appears today. Note that left lean-to addition (switchroom) is no longer present. Date removed unknown. Photo by R. Sackett.....	52

LIST OF MAPS

Map 1. Eklutna Power Project and Vicinity	17
Map 2. Project Boundaries	22
Map 3. New Eklutna Power Project	50

CHAPTER 1.0 Introduction

Anchorage's early electricity sources are an often overlooked topic in the city's history. Yet power was extremely important in establishing Anchorage as a permanent town. Without a reliable and economical supply of electricity it would have been very difficult for the young city to maintain any level of growth.

The town was initially served by a steam power plant built by the Alaska Engineering Commission (AEC). The 900 kW facilities supported Anchorage power needs from 1916 until 1929 when a private company, Anchorage Light and Power (AL&P), completed a hydroelectric power plant at Eklutna.

Local businessman, Frank Ivan Reed, developed the Eklutna power plant. He began working on a plan in 1920, when AEC engineer John J. Longacre determined that hydropower was possible at Eklutna. In 1923, Reed formed the Anchorage Light and Power Company. Five years later, in September of 1928, the company began construction after a lengthy financing and authorization process. On October 8, 1929, AL&P started supplying Anchorage with electricity. Frank I. Reed sold the power plant to the city in 1943. The plant continued running under city supervision for the next ten years until a larger hydroelectric power plant was constructed. The old Eklutna power plant, as the first facility has come to be known, served Anchorage for over 25 years. In that time Anchorage grew from a small railroad settlement into the largest city in Alaska.

This study was carried out for US Army Alaska, Fort Richardson, in order to comply with Section 110 of the National Historic Preservation Act of 1966 (as amended). The purpose of this report is to establish the historic context of the Old Eklutna power plant. This is necessary so that Fort Richardson may identify and assess remains associated with the system that are found on its land.

These remains consist of a large section of the electrical transmission line. Approximately 38% (10 miles) of the original line lies on Fort Richardson. Though sections of the line were removed, a substantial number of poles remain with cross arms and insulators in good condition. Also, approximately three miles of the original line ran across what is now Elmendorf AFB. Twelve poles were located near the southwestern Fort Richardson boundary; the rest were removed at unknown dates.

1.1 Acknowledgements

Sincere thanks to Frank M. Reed Sr. for sharing many stories, photographs and documents. Without his generous assistance this report



Figure 1. Frank M. Reed Sr. next to Eklutna powerhouse plaque. Plaque used to hang next to front door on powerhouse. Photo by K. Hollinger, 23 Aug. 2001.



Figure 2. Close-up of Plaque. Photo by K. Hollinger. 23 Aug. 2001.

would not have been possible. Unless otherwise noted, all photographs are from the collection of Frank M. Reed Sr.

Special thanks to Ken Hinchey, Rae Kozlowski, Jane Lee, Pat Leddy, Mary Ada Peery and Carmel Tysver for sharing memories of life at the Eklutna camp. Also, thanks to Russell Sackett, USARAK Cultural Resources Manager, for guiding the project throughout its development. Thanks to William Quirk for conducting numerous aerial surveys of the transmission line, Douglas Johnson for helping to locate the line on the ground, Markus Geist for GPS assistance, and Jeff Andrews and Steven Drake for

helping with the maps. Finally, thanks to Mina Jacobs and Diane Brenner of the Anchorage Museum of History and Art, Bruce Parham of the National Archives Alaska Pacific Region and Bruce Merrell, Alaska Bibliographer: Loussac Library, for assistance in locating photographs, books and documents. This report was written with the cooperation of Elmendorf Air Force Base, 3rd Civil Engineering Squadron, Environmental Flight.

CHAPTER 2.0 Methodology

This report was researched in consultation with Frank M. Reed Sr., the son of Frank I. Reed. His memory of early AL&P events and his father's activities was an invaluable source of information for this project. Mr. Reed's recollections were supplemented with documentary evidence collected from four main sources: the National Archives, Pacific Alaska Region; the University of Alaska Anchorage's Manuscripts and Records Department; the personal collection of Frank M. Reed Sr.; and the Anchorage Daily Times for the main years of the project construction—1928 to 1929.

Frank M. Reed Sr.'s personal collection contained information relating to the operation of the power plant and early attempts to sell the facilities. His files contained a large volume of personal correspondence to and from Frank I. Reed with parties having business with AL&P. The bulk of communication was to and from: Pemberton & Son; Vancouver Limited Investment Bankers, Jasper-Stacy Company, Russell-Colvin Company and the Bank of Alaska. Also included were AL&P annual reports for the years 1930 and 1933.

The National Archives, Pacific Alaska Region held files in Record Group Number 447, Alaska Power Administration historical files and photograph collection from 1948 to 1998. Most information was located in Box 42, File: Fair Market Value and Severance Damages Applicable to Hydroelectric Properties and Rights of City of Anchorage, Alaska. The file described the physical condition of remaining structures, outlined land and water rights, and provided photographs, maps and blueprints.

Information on AL&P's pre-construction activities was found in the University of Alaska Anchorage, Archives and Manuscript Department, Frank Reed Sr. Papers. Frank M. Reed Sr. donated the files to the archives in 1982. The papers contained one folder of information (Box 19, Series 7E, Folder 1) related to early AL&P activities including: AL&P's articles of incorporation, city council meetings notes, minutes of AL&P board meetings, and an early report on the suitability of Eklutna Lake for hydropower development with an examination on the proposed market for power in Anchorage.

With this large volume of primary documentation available and over sixty newspaper articles from the Anchorage Daily Times, it was possible to piece together a detailed narration of AL&P's early organization, financing, construction, and operation.

But few records were found to document the period when the city took over the power plant in 1943. The author located several Anchorage residents who lived at or visited the power plant from 1943 to 1955 and who provided detailed accounts of camp life. However, none of the city employees were found. Therefore, this report focuses on AL&P's period of development and ownership of the old Eklutna power plant.

CHAPTER 3.0

Anchorage and Early Electricity

The city of Anchorage was established in 1915 when President Woodrow Wilson extended the Alaska Railroad route from Seward to Fairbanks. Anchorage was selected as the Alaska Engineering Commission's (AEC) new headquarters for building the railroad. Prior to 1915 there were very few people in the Anchorage area save a handful of scattered homesteaders. The indigenous population (the Dena'ina) was concentrated in the village of Eklutna.

Many had anticipated the railroad's route and were already settling in the area. A "tent city" sprang up seemingly overnight on Ship Creek Flats. People flocked to Anchorage, hoping to get jobs with the railroad or to supply goods and services for the workers building the line. The AEC took on most management and organization responsibilities for the community.

Tent city was disorderly at first. Trash was dumped in the outgoing tides of Cook Inlet, and there were no sewers. Officials were concerned that drinking water would become contaminated if things were not cleaned up. The land office stepped up the pace of surveying a new 350-acre town site on the bluff on the south side of Ship Creek. On July 10, 1915, the auctioning of town lots began, and within a few days, 655 lots were sold for a grand total of \$150,000. The AEC instructed people to move off Ship Creek Flats to the new town site by August 16th. On the north bluff, what is now known as Government Hill, the AEC laid out housing for employees.

People began flooding into the new town and erecting permanent structures. In 1916, wide concrete sidewalks were built down Fourth Avenue, and AEC completed construction of a power plant in the rail yard. By 1917 between 6,000 and 7,000 people lived in Anchorage, though only 4,000 were permanent residents. Many of the early settlers were immigrants from Greece, Russia, Norway, Sweden and Denmark seeking work with the railroad.

World War I caused problems for Anchorage and the Alaska Railroad as men left the territory to join the military. By 1918 the railroad was suffering a severe labor shortage; the 1917 work force of 5,675 men was halved. An influenza epidemic further depressed the economy in 1919. There were only around 2,200 people residing in the town when it was incorporated as Anchorage in 1920.

While the rest of the United States enjoyed a decade of growth and prosperity, Anchorage's economy faltered when men did not return to the territory after World War I. Gold and fish prices dropped, and the Alaska Railroad began losing money at an alarming pace. By 1930 there were only 5,400 people in Anchorage, Seward and Fairbanks combined.¹

¹ Kristy Hollinger, *Homesteads on Fort Richardson, Alaska* (Colorado State University, Center for Ecological Management of Military Lands, 2001) pp. 11-13.

3.1 Anchorage Power

The AEC was the sole power supplier in Anchorage from 1916 until the completion of the Eklutna power plant in 1929. The Anchorage Chamber of Commerce considered government owned and operated facilities desirable in order to “keep the town out of petty political fights” over the interests of competing private companies.² The AEC’s steam-generating power plant was in the rail yard, fifty feet from the machine shop.



Figure 3. AEC powerhouse. Courtesy of Anchorage Museum of History and Art, ARR collection, BL79.2.3411.

AEC personnel carried out all maintenance and construction operations, including the construction of the transmission lines for the city’s use. In 1921 the city leased the distribution system, and Anchorage Public Utilities took charge of retail sales.³

In 1920 a fire destroyed the original power plant building, and a new concrete structure was erected in its place. This building still stands today.⁴ The steam plant was fed by coal transported to Anchorage over rail from Matanuska Valley. The coal was dumped from railroad cars into bunkers that fed to the boilers. Part of the equipment such as boilers, feed pumps and direct current

generators, was recycled from Panama Canal work. The railroad used steam from the plant to heat its machine shop.⁵

Service was limited to those directly in the city limits. Supplying the market was a challenge at times due to the plant’s limited facilities. A 1917 railroad circular asked that “the lights when not required to transact official business should be turned off, in order not only to reduce the cost of maintenance, but also with the view of increasing this service to the extent the present plant is capable of.”⁶ Average annual production of power amounted to 1,112,327 kWh, of which, the Alaska Railroad used approximately 700,000 kW. Power was sold to the city at a flat rate of eight cents per kW hour.⁷ The AEC made little profit from the sale of its electricity.

The railroad’s power plant was adequate for a time. But it was expensive to operate, particularly when one considered the cost of purchasing and shipping coal to the plant. Later photographs of the railroad’s power plant reveal it as antiquated and vulnerable to fire hazards. Generating electricity for Anchorage was not a primary function of the commission’s operations. The AEC had neither the time, resources, or inclination to expand the plant’s capabilities as the city and surrounding areas grew. Anchorage Light and Power Company

² “Light and Power Are Discussed,” *Cook Inlet Pioneer*, 21 Aug. 1915.

³ Michael Carberry and Donna Lane, *Patterns of the Past: An Inventory of Anchorage’s Historic Resources*. (Municipality of Anchorage: Community Planning Department, 1986) pp. 106, 107.

⁴ *Ibid.*

⁵ “Anchorage Power Plant,” *Alaska Railroad Record*, Vol. 1 No. 2, 21 Nov. 1916.

⁶ Circular No. 164, *Alaska Railroad Record*, Vol. 1, No. 13.

⁷ Robert Howes, Markets for Power Report, 8 May 1924. Frank M. Reed Sr. Papers, Box 19, Series 7E, Folder 1. University of Alaska, Anchorage (UAA) Archives and Manuscripts Dept.

AEC PLANT CONTROVERSY

The AEC power plant came to Congressional attention in the early 1930s. At that time, the Alaska Railroad was under intense scrutiny due to its dismal profit margins. A Nebraska senator, Robert B. Howell, was particularly critical of the AEC's agreement to purchase electricity from the Anchorage Light and Power Company. He condemned the loss of revenue from the railroad's power sales and criticized the high cost of using the steam plant for heating the railroad's machine shops. Though Howell's criticism regarding lost profits from power sales was unfounded, his remarks instigated a renegotiated, cheaper power rate from AL&P. The railroad rethought its use of the steam plant for heating purposes and discontinued use of the facilities. The power plant remained idle until the 1940s. At that time the city of Anchorage was experiencing a population explosion caused by World War II military buildup. The city was forced to request that the railroad put the plant back on line to mitigate power shortages.

— Carberry and Lane. *Patterns of the Past: An Inventory of Anchorage's Historic Resources*. p. 107.

noted in an early report, “the supplying of this current appears to have been rather burdensome to the commission, and city officials say the growth of demand for electric current has been forced by the consumer and not encouraged by the operators.”⁸

The railroad enthusiastically supported development of the Eklutna hydroelectric project. Pledging to buy power from the company, it also agreed to maintain its own plant for heating its maintenance shop and for Anchorage's emergency power needs. Railroad management at the time saw development of the Eklutna plant as beneficial in two ways. One, it would provide cheaper electricity for the railroad's own power needs. Two, cheaper electricity would stimulate more business ventures around the city, thus increasing freight possibilities for the railroad. The opportunity for more business and money-saving schemes came at a time when the railroad badly needed to make a profit.⁹

⁸ Ibid.

⁹ Ibid.

CHAPTER 4.0 Environment

Eklutna Lake lies in Chugach State Park, a half million-acre nature reserve bordering Anchorage. Midway between Anchorage to the south and Matanuska to the north, it is the largest water body in the park. Eklutna Lake presently plays a multipurpose role in the community, serving as a recreation spot, drinking water source, and providing water to power the modern hydroelectric plant.

The lake is nestled in the Chugach Mountains at 868 feet above sea level. Retreating glaciers, which left a natural dike facilitating water storage, formed the lake basin.¹⁰ The lake is located in the larger glacial feature of Eklutna Valley. The valley is a steep-sided, trough-like area approximately 23 miles long.¹¹



Figure 4. Eklutna Valley and Lake. Courtesy of Anchorage Museum History & Art, WWS 0107-R03.

Eklutna Lake, which is about 32 miles from Anchorage, is 7 miles long, 3/4 of a mile wide, and up to 200 feet deep in areas.¹² It has a storage capacity of 138,000 acre-feet. Eklutna Creek (East and West fork), stemming from Eklutna glacier, feeds into the lake and is its primary water source. Eklutna Glacier is 8 miles long and starts at the peaks of the Chugach Mountains at an elevation of 6,000 feet, terminating at 1,200 feet. The glacier has retreated about 1 mile in 30 years. Currently it is about 4 miles away from the lake.¹³

Annual water volume of the lake varies widely between the summer and winter seasons. In winter, flow from the creeks is minimal due to limited precipitation and low temperatures freezing the water. It is during the summer months that most of the lake's water is collected and the maximum storage capacity may be reached.¹⁴ The Eklutna River drains the lake, flowing from the north-west corner and emptying into Knik Arm. The shores of Eklutna Lake are generally very rocky due to glacial deposits, and the valley walls are dominated by dense spruce and birch forest.

¹⁰ Alaska Power Administration: U.S. Department of Energy. *Eklutna Hydroelectric Project*. Palmer Alaska.

¹¹ Joseph M. Morgan. *Eklutna Project to Serve 25% of Alaskans*, Alaska Support Office, Bureau of Reclamation, 1948, pp. 15, 16.

¹² Alaska Power Administration: U.S. Department of Energy. *Eklutna Hydroelectric Project*. Palmer Alaska.

¹³ Timothy P. Brabets. *Glacier Runoff and Sediment Transport and Deposition: Eklutna Lake Basin, Alaska*. Water Resources Investigations Report 92-4132. (Anchorage, Alaska: United States Geological Survey, 1993), pp. 1-5.

¹⁴ *Ibid.*, pp. 5, 6.

CHAPTER 5.0 Hydroelectric Power

5.1 Technology

Hydroelectric power taps the flow of running water falling down a vertical distance to produce an electric current. Though hydroelectric plants vary in their design and complexity, all share several key characteristics to generate power. First there must be a relatively steady water source. This may take the form of a lake, stream, or river. The water must then be channeled so that it falls a controlled vertical distance. The vertical distance the water falls from the source, usually measured in feet, is referred to as the head. The water must then be directed through a turbine. The power of the rotating turbine is transferred to a generator that produces electricity. The generators must be shielded from the elements, and so a powerhouse is built to protect the generating equipment. The amount of energy produced by a hydroelectric facility is directly related to the head and the overall amount of water available or flow. The equation $P \text{ (Power)} = Q \text{ (Flow)} H \text{ (Head)}/11.8$ gives the wattage that can be generated.¹⁵

All hydroelectric installations have a power-producing capacity related to the actual size of the turbine (or turbines) in their facilities. The capability is measured in watts and is referred to as a plant's installed capacity. Installed capacity available, however, does not mean that amount of power is automatically produced. Various factors, such as load requirements or inadequate water flow will determine the amount of use of the installed capacity. The annual average amount of energy actually produced by a plant is known as the plant factor.¹⁶

There are two basic types of hydroelectric installations—low head and high head. Low head installations use a smaller head, usually from 10 to 50 feet. These require a large volume of water to pass through the turbines in order to make up for the lack of head. This type of plant may use a low dam, or just the “run of the river,” for its water supply. High head installations are more common. These generally use a dam to store water at a higher elevation. Dams provide a constant and steady water supply even during dry periods of the year. High head works do not require as much water volume to produce power.¹⁷

Hydroelectric installations usually have a very long production life, lasting anywhere from 30 to 50 years or more. This may or may not be advantageous, depending on how well the future power needs of an area can be predicted. If later demand is undervalued, then the system will be too small and may require expensive upgrades. If demand is over estimated, the installation will be too large to pay for itself, hurting profits. Determining power needs just five years in advance is often difficult. Figuring out what will be needed 30 or even 50 years down the line may be all but impossible.¹⁸

¹⁵ Neil Davis. *Energy / Alaska*, University of Alaska Press, 1984, pp. 309-312.

¹⁶ Ibid. p. 312.

¹⁷ Neil Davis. *Energy / Alaska*.

¹⁸ Ibid. p. 313.

5.2 Hydroelectric Power in Alaska

Alaska has immense potential for hydroelectric installations, large and small. It is estimated that nearly one third of America's waterpower resources are located in the state. Most potential is concentrated in southeast and south-central areas of Alaska. Several features make these locations uniquely adapted to hydroelectric power. The rugged terrain with high elevation lakes, rivers and streams provides ideal head conditions. The area's high precipitation rates guarantee a steady water supply, and the glaciers provide additional water storage. There are a few problems unique to Alaska, which are unusual in warmer regions. The rough terrain, lack of infrastructure, and cold winters may make construction difficult and impossibly expensive in some areas. Formation of ice on water sources and in the surrounding air during the long winters is also a concern.¹⁹

It is important to remember that potential is not synonymous with actual use. Though Alaska has huge hydroelectric capabilities, the state does not make use of a quarter of its waterpower resources. Environmental concerns, construction costs, and cheaper alternative fuel sources all contribute to this situation.

In the past, hydroelectric power played a much greater role in supplying Alaska with energy. First documented use occurred with the Russians in 1840 at Sitka.²⁰ Use increased over time, peaking in the early 1900s when waterpower became essential in developing many industries. Early installations varied in their capabilities, but as John Whitehead states:

In the first two decades of the 20th century, it could easily be said that technology in Alaska reached a "state of the art" level for small hydro plants, unsurpassed anywhere in the world. A number of plants built in this period have been operating continuously to the present day. And in many respects the engineering in those plants has not been improved upon in more recent installations.²¹

Many small-scale operations were constructed throughout south-central and southeast Alaska to power mining, canning and sawmill businesses. By 1908 there were at least 30 hydro installations of varying sizes in southeast Alaska alone, providing a total 11,500 kW of energy.²²

Private businesses were not the only ones interested in Alaska's waterpower resources. The federal government was also eager to explore and tap hydroelectric possibilities. The Forest Service, Federal Power Commission and the U.S. Geological Survey were all involved in surveying hydropower capabilities and gauging stream flows throughout the state. Many early reports were extremely enthusiastic about potential development of hydroelectric installations.²³

¹⁹ Ibid. pp. 307, 308.

²⁰ Gene Routledge. *Alaska's Energy Resources*, Anchorage, AK: Wolfe Business Services. 1985, p. 217.

²¹ John Whitehead. *Hydroelectric Power in Twentieth Century Alaska: Anchorage, Juneau, Ketchikan and Sitka*. Bulletin of the Institute of Water Resources, Vol. 2, University of Alaska, Fairbanks: 1983, p. 15.

²² Ibid. p. 1.

²³ Gene Routledge. *Alaska's Energy Resources*, p. 217.

If the first two decades of the twentieth century were a boon for hydroelectric development in Alaska, the following two decades saw use taper off. As mining, canning and pulp industries declined, the need for waterpower to fuel individual industries correspondingly declined. Fossil fuel sources such as coal, natural gas and oil became cheaper and started replacing hydraulic developments. The high cost of constructing hydroelectric facilities discouraged continued use of waterpower. As financial futures became uncertain, many businesses preferred not to make the long-term investment required for hydroelectric construction. Diesel generators and oil fuel became more desirable to many businesses.²⁴

²⁴ Neil Davis. *Energy / Alaska*, p. 317.

CHAPTER 6.0 Eklutna Power Project

6.1 Project Development: 1920–1928

The Eklutna area holds an ideal hydroelectric resource for the community; a fact that was promptly recognized by Anchorage citizens. An early report to the Federal Power Commission stated, “There has long been an opinion prevalent among those having some knowledge of the country that the Eklutna River afforded the best if not the only feasible site for hydroelectric development in this vicinity.”²⁵ The Alaska Engineering Commission conducted broad surveys of the area to determine the extent of hydroelectric potential. A fire that severely damaged the Anchorage steam power plant prompted this surveying, the main interest being to investigate alternative energy sources.²⁶

In December of 1921, AEC engineers John Longacre and C.D. Pollock visited Eklutna Lake to gather preliminary feasibility information. Their brief survey resulted in a highly favorable recommendation regarding future development of the lake for hydroelectric power production. The findings were relayed to the head Anchorage engineer, and a more intensive survey of Eklutna River, from the railroad to the lake, was authorized. James Truitt and members of the maintenance engineer party began this survey in January of 1922. The crew was available since severe weather conditions had made their normal duties impossible. The survey party determined exact dimensions of the lake, established a weir to measure water discharge, and gathered data on basic characteristics of the lake, river and surrounding area.²⁷

For reasons relating to the cost and the time that development entailed, the railroad quickly ended its involvement in the Eklutna site. It was then that local businessman Frank I. Reed decided to take matters into his own hands. He had first visited the area in 1915 while on his way to Cache Creek.²⁸ As Reed’s son, Frank M., recalls, “My dad had spent a number of years in Nome, twelve years in Nome, working with hydraulic mining, and he understood the power of water and how it could be used.”²⁹ Reed and AEC engineer John Longacre teamed up and began efforts to develop a power plant at Eklutna in earnest. Reed and Longacre knew each other from being on Anchorage’s first city council in 1920. From 1922 to 1928, a significant amount of time and money was dedicated to getting the project off the ground. Over five years \$25,000 was expended in research and development.³⁰

²⁵ *Report on Proposed Hydro-Electric Plant on Eklutna River*: National Archives - Pacific Alaska Region. Record Group 447, Alaska Power Administration, Box 42, File: Fair Market Value and Severance Damages, p. 1.

²⁶ Carbery and Lane. *Patterns of the Past: An Inventory of Anchorage’s Historic Resources*, p.106.

²⁷ *Report on Proposed Hydro-Electric Plant on Eklutna River*: National Archives—Pacific Alaska Region, Record Group 447, pp. 1-3.

²⁸ “Chance Launched Power Project: Success Achieved by Hard Work Backed by Faith in Enterprise,” *Anchorage Daily Times*, 21 Sept 1929, p. 13.

²⁹ Frank M. Reed Sr., personal interview with author, 30 April 2001. p. 6.

³⁰ Box 19, Series 7E, Folder 1. Frank Reed Sr. Papers, UAA.

FRANK I. REED



Figure 5. Portrait of Frank I. Reed.

Frank I. Reed was born in Council Bluffs, Iowa, in 1872. He had four sisters and one brother. Reed moved to Nebraska as an adult and worked as a railway expressman. He volunteered to serve in the Spanish American War with his brother, Charles, in 1898. They served in the Philippines during the Philippine American War (commonly referred to as the Philippine Insurgency) immediately following the Spanish American War. While in the hospital suffering from malaria,

the brothers decided that rather than return to Nebraska, they would go north to Alaska. They sailed for the territory in April of 1900 on the *SS Zelandia*.

On the voyage, Reed met sixteen-year-old Pauline Hovey who was traveling with her mother and two sisters. Pauline and Frank struck up a friendship, and four years later the two were married in Seattle.

Frank I. Reed's first years in Alaska were spent in Nome working for the Solomon Dredging Company. Pauline and Frank had two sons: Paul, born in 1907, and Frank M., born in 1912. The family lived in Seattle for several years while Frank I. worked in the Talkeetna area to establish a gold dredging operation near Cache Creek. In 1915, they moved to the new town of Anchorage. Frank M. recalls that his father invested in a lumberyard selling materials to those building the Anchorage Hotel on 3rd and E Street. When the hotel was finished, the businessmen could not pay for the lumber. Reed took over the hotel to satisfy the debt. The Reeds lived in and managed the successful hotel until 1935.

Frank I. Reed was a very active member of the Anchorage community. He served on the first city council in 1920 and later as president of the chamber of commerce. He also promoted construction of a road to Palmer, and influenced the fire department to change from a horse and wagon operation to motorized American La France engines. Reed's most noteworthy activity, however, was the development and construction of the Eklutna power plant. This endeavor took up a considerable amount of his time and financial resources from 1922 until its completion in 1929. The income from the Anchorage Hotel provided the monies for the initial project development.

Sources:

- Frank M. Reed Sr., Personal Interview with author, 10 April 2001.
- *Pioneers of Alaska*, Igloo 15, Auxillary 4, 1996.
- *Fond Memories of Anchorage Pioneers*, Vol. 1, pp. 186-187.

On September 28, 1922, Reed filed a preliminary permit application with the Federal Power Commission.³¹ In October he posted a notice of location of water rights on the land. The notice read:

Know all men by these presents, that I, the undersigned, do hereby claim five hundred cubic feet per second of the water flowing in this stream, known as the Eklutna River, for the purpose of generating electric energy to be used for light and power at points along the U.S. Railroad and Willow Creek section of the Knik Recording Precinct. Water to be diverted at the point of the river opposite this notice by the erection of dam and other works and conveyed to powerhouse to be constructed near the mouth of the Eklutna River. Application for permit and license to use this water and land for impounding same to be made to Federal Power Commission.

This served as public notification of Reed's intent to use the land. On March 9, 1923, the FPC granted Frank Reed the preliminary permit. The operation was designated Project Number 350. The permit stipulated a two-year time frame in which to provide the necessary information for issuance of a license for actual construction and operation of the Eklutna hydroelectric power plant.

The same year the preliminary permit was issued, Reed formed the Anchorage Light and Power Company (AL&P). It was tasked with development of the hydroelectric power plant at Eklutna. Initially the company started out with a board of directors consisting of three people: Frank I. Reed (President), John J. Longacre (Vice President and Treasurer), and Chas LaCoste (Secretary). Longacre and

³¹ The Federal Power Commission was established in 1920 as the agency in charge of granting federal energy permits to private interests on federal lands.

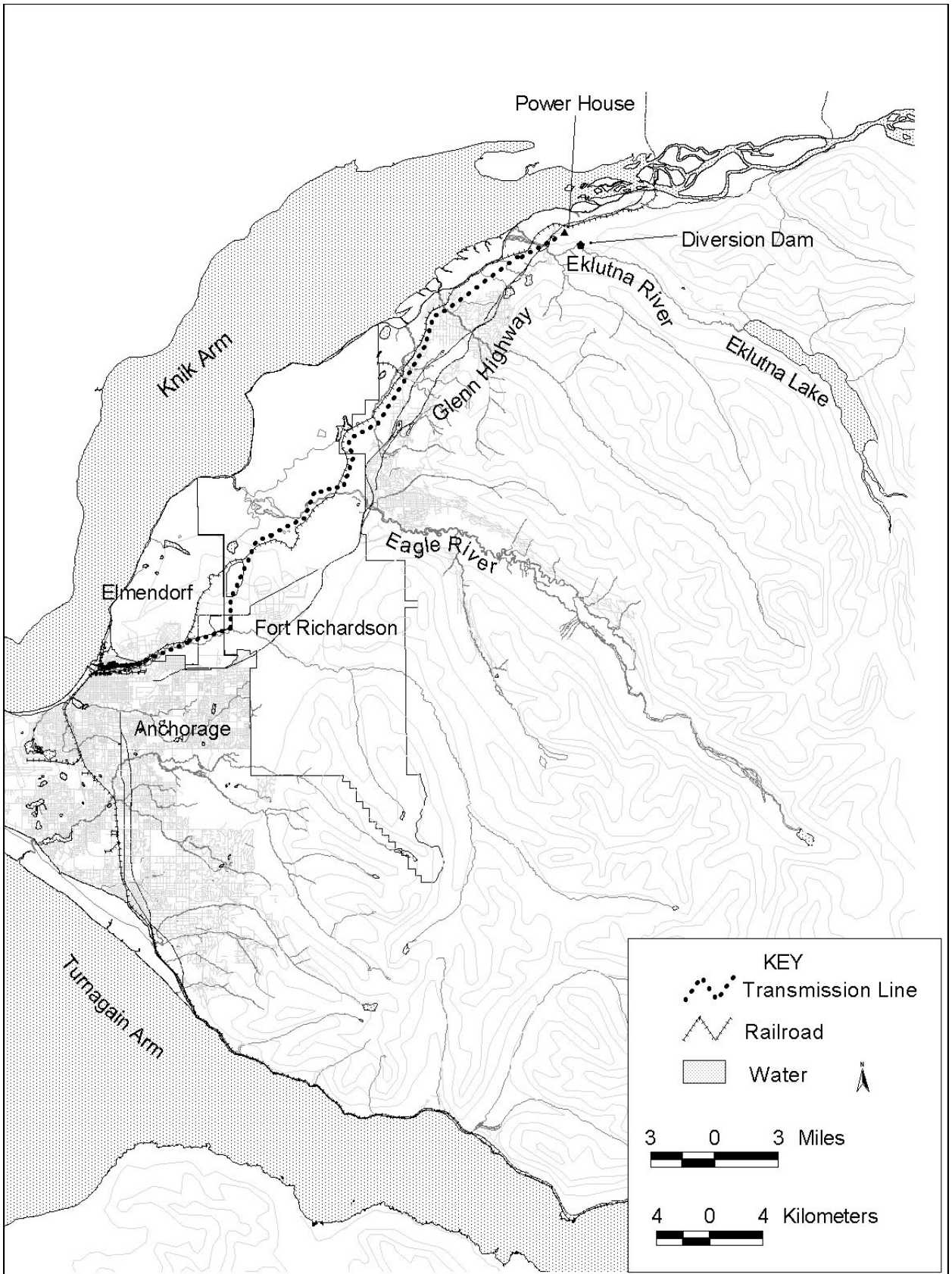

Map 1. Eklutna Power Project and Vicinity.

LaCoste resigned in 1927 and were replaced by J.B. Gottstein and Harry F. Morton, respectively. Morton was also the company attorney. An early AL&P report stated that the company was formed for the purpose of “pooling assets, procuring sufficient monies for preliminary surveys, together with other expenses in launching the project for financing.”³²

There was a great deal of work to be done by AL&P board members in order to get the FPC’s approval for the issuance of a license. They had to prove there was a viable market for power in the area, prepare construction plans, survey a transmission line route, and procure agreements from the Alaska Railroad and the city of Anchorage to purchase power from AL&P when the project was completed.

In 1924 Reed hired Seattle engineer Robert Howes to conduct initial studies of the Eklutna undertaking. Howes examined the market for power, the environment and climate of the proposed site, transportation issues, lake characteristics, head conditions, cost projections and other aspects of the project. He conveyed his findings to Reed in a detailed report that concluded the project was “one of decided merit, presuming that you can conclude contracts to supply the requirements of the vicinity of Anchorage.”³³

Howes determined that there was a healthy and steady growing demand for electricity in the Anchorage area. For instance, in 1922 Anchorage purchased 469,137 kW from the Alaska Engineering Commission. In 1923, this amount increased to 512,282 kW—a yearly gain of 43,145 kW. Howes assumed the growth would continue at a steady rate.³⁴

AL&P’s assured market for power relied on three principle consumers—the city of Anchorage, the Alaska Railroad and city water pumping. The railroad had agreed to purchase power from AL&P in 1924. A contract with the city had yet to be approved. The delay in this agreement may have kept AL&P from an earlier development schedule.

The Eklutna Industrial School was also certain to buy power from AL&P. The school was established in 1924 by the Bureau of Education to provide industrial training to Alaska native children orphaned by flu epidemics. A letter to Frank I. Reed stated its eagerness to buy power:

Dear Sir, we are anxious to know how soon you expect to have your electric power plant in operation. We are at present using two Kohler light plants, a stationary gasoline engine and a tractor with which to furnish our light and power. We expect to build this summer and to put additional equipment into our shop, therefore we are anxious to know at the earliest possible date when we may expect to secure power from your company, that we may order electrically driven equipment and wire our building for the same.³⁵

Other potential markets that could be developed outside the immediate Anchorage city limits were identified. These were Matanuska, Wasilla, Jonesville,

³² Box 19, Series 7E, Folder 1. Frank M. Reed Sr. Papers, UAA.

³³ Robert Howes. “Markets for Power Report,” 8 May 1924, p. 10. Frank M. Reed Sr. Papers, UAA.

³⁴ Ibid.

³⁵ Letter to Frank I. Reed. On file Frank M. Reed Sr. Papers, UAA.

Moose Creek and the Willow Creek mining districts. The areas were eager to adopt cheaper hydroelectric power sources. Due to power limitations, several mines were restricted to operating only during summer months. With inexpensive hydroelectric energy they could expand to year-round work.³⁶

At the end of the year Reed realized that the project would take longer to develop than anticipated. He applied to the FPC for a one-year extension of the preliminary permit. On April 4, 1925, the FPC granted the amendment to the original application allowing Reed until March 8, 1926, to furnish all necessary facts.

On June 15, 1927, AL&P submitted a proposal to the municipal council that offered to provide the city with electricity for municipal use and for retail distribution within the city limits. The proposal, Ordinance No. 68, outlined the terms of the contract and set rates for power consumption. On June 20, 1927, the city council held a public meeting to familiarize people with AL&P's proposal and to solicit opinions. The Alaska Railroad sent B.H. Barndollar to speak on its behalf. The railroad fully supported the Eklutna power project. Fifteen to twenty people expressed

POWER PLANS OF EKLUTNA PROJECT GIVEN APPROVAL

FRED H. TIBBETTS SAYS CONDITIONS IDEAL FOR HYDRO-ELECTRIC PLANT

The utilization of the waters of Eklutna lake for the generation of electric energy does not present any difficulties, in the opinion of Fred H. Tibbetts, San Francisco engineer, who came to Alaska for the purpose of passing on the merits of the project and determining the character of the plant to be installed for the Anchorage Light & Power company.

"There is a ready-made lake which is ideal for the purpose," Mr. Tibbetts informed The Times, "but the most advantageous feature of the project is the ease with which the river can be regulated. The erection of a 15-foot dam at the lake will provide sufficient water at all seasons of the year for the requirements of the project for many, many years. A 15-foot dam would provide four times as much water as the plant could handle during the winter months at some time to come."

The storage of water for hydroelectric plants in California, where Mr. Tibbetts has had the direction of a number of big projects, is usually attended with greater difficulties than will be encountered at Eklutna, Mr. Tibbetts says. Most of the California storage is higher up in the Sierras, at an altitude of from 5,000 to 7,000 feet, where there is heavy fall of snow, extremely low temperatures during the winter and severe storms. More than half the cost of one project involving a total outlay of more than \$7,000,000, was expended for storage. At Eklutna the stream regulation is a very simple matter.

— Anchorage Daily Times, 11 Aug. 1928

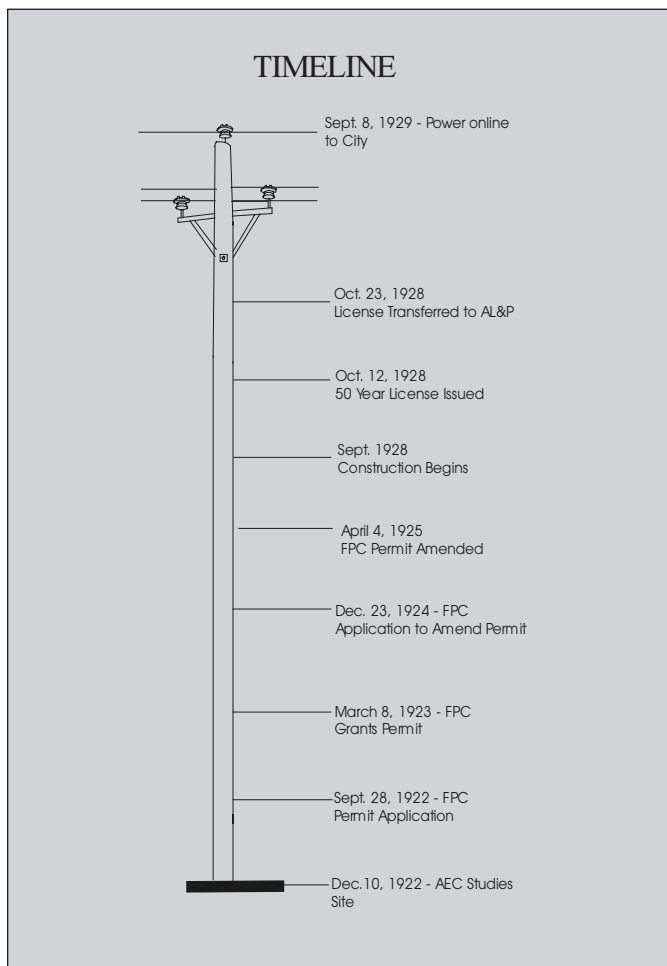

³⁶ Robert Howes. "Markets for Power - Markets Other Than at Anchorage," Frank M. Reed Sr. Papers, UAA. 8 May 1924.

OAKLAND

PORTLAND

TELEPHONE KEARNY 7100



RUSSELL-COLVIN COMPANY

MUNICIPAL AND CORPORATION BONDS
MILLS BUILDING
SAN FRANCISCO

June 25, 1928

Anchorage Light & Power Company
Anchorage, Alaska

Dear Sirs:

Our investigation of your water-power project has progressed to the point where we are satisfied to undertake its major financing, upon our having evidence of your ability to obtain sufficient funds locally to provide a reasonable margin of safety for the total investment necessary to complete the work to be done.

Subject to the foregoing, we propose to deliver to your company, before our departure from Anchorage this week, a binding underwriting agreement covering the purchase by us of your First Mortgage Bonds and Preferred Shares, to an approximate total of \$300,000.00, to be issued as outlined between us.

In the event you do provide the funds referred to above, our construction engineer in San Francisco will leave immediately for Anchorage and work on the project will be begun and carried thru to completion as early as possible in the coming year.

Our investigation has been most thorough and, we believe that the project not only is sound but also, if carried thru, will prove to be the fore-runner of much further development in this section of Alaska.

Appreciating the co-operative spirit shown by all during our investigation, we are

Yours very truly,

RUSSELL COLVIN COMPANY

By _____
Vice-President

By _____
Vice-President

opinions during the meeting and only one was opposed to the arrangement. Several other meetings were held to acquaint interested parties to Proposed Ordinance #68.³⁷ The ordinance was authorized during a city council meeting on July 18, 1927. It bound the city to a fifteen-year contract with AL&P for the purchase of electric power for industrial, commercial and domestic purposes.³⁸ Reed immediately sent out a telegram to his attorney, Sheffield Bridge, in San Francisco reading, "City council passed ordinance in favor of Power Company. Mayor and clerk have signed contract for light and power today."³⁹

With contracts from the city and the railroad concluded and a permit from the FPC approved, the long process of authorizing the project had at last come to an end. The final hurdle to be surmounted was obtain-

ing money to finance the costly construction work. This was a matter Reed had been working on throughout the past four years. Eventually he gained the support of the Russell-Colvin Company, investment bankers in San Francisco. Russell-Colvin sent Ronald R. Berliner, Vice President, to Anchorage to investigate the projects value. He concluded it was an extremely worthy venture that could be expected to produce healthy profits and stimulate the economy.⁴⁰ Berliner made one recommendation—that the city extend the lease on the Alaska

³⁷ Extracts From the Minutes of the Regular and Special Meetings of the City Council, Anchorage Alaska, Pertaining to Ordinance No. 68. 15 June, 20 June, 2 July, 1927. Section 3. Frank M. Reed Sr. Papers, UAA.

³⁸ Ordinance No. 68, Anchorage, Alaska. Frank M. Reed Sr. Papers, UAA.

³⁹ Copy on file, Frank M. Reed Sr. Papers, UAA.

³⁹ Copy on file, Frank M. Reed Sr. Papers, UAA.

⁴⁰ Russell-Colvin Company to AL&P. 25 June 1928. Personal Collection of Frank M. Reed Sr.

Railroad's distribution system. The city council quickly approved this action.⁴¹ Russell-Colvin set up a bond issue worth \$750,000 to finance the construction. The bonds were to run until August 1, 1943.⁴² A capitalization of \$1,000,000 consisting of 100,000 shares of stock at \$10 per share was created. Of this, 60,000 shares were common stock and 40,000 shares were preferred.⁴³ Many in Anchorage purchased stock in the company.

MURDER

On March 26, 1929, AL&P employee, Matthew "Goldtooth" Murphy was shot by William Myers. Myers owned a homestead bordering land that the powerhouse was built on and a section of the tailrace ran through Myers' property. Apparently Myers was a moonshiner and he occasionally sold liquor to the men working at the construction camp. On March 25, Myers and Murphy had an argument over whether Murphy could take liquor on credit. Myers refused to give Murphy alcohol unless it was paid for up front. Murphy decided that didn't suit him and he picked up a bottle and left with it. The next morning, Myers walked into the camp with his rifle and started firing at Murphy. Murphy made no attempt to defend himself. Walking closer with each shot, on the third or fourth shot Murphy was hit and fatally wounded. He died before a doctor arrived at Eklutna.

After shooting Murphy, Myers walked to the AL&P office at the head of the camp. The men in the office, including Frank Reed, feared for their safety and all crowded into a small bathroom. Frank M. recalls, "There were three men in that place suddenly! And old man Myers stood at the counter and waited. And pretty soon my dad decided he had to go out, and went out, and the old man says, 'Well, I finally done it. I've broken all the commandments now. You better call the Sheriff.'"

Sheriff Walter Culvers arrived and took Myers into custody. A few weeks later, Myers was convicted of manslaughter and sentenced to fifteen years in prison. Harry F. Morton, AL&P's own attorney, represented him. The punishment handed down was essentially a life sentence, since Myers was already 70 years old at the time.

Sources:

- "Witnesses Relate Details of Death, Eklutna Shooting," Anchorage Daily Times, 28 Mar. 1929.
- "Myers Sentenced for Slaying Man at Eklutna Camp," Anchorage Daily Times, 29 June 1929.
- Frank M. Reed Sr., personal interview with author, 10 April 2001, pp. 5, 6.

6.2 Land Rights

The Eklutna Power Project resulted in significant changes in land use. Land rights were obtained through the Federal Power Commission's issuance of a permit for the construction and operation of a power plant on federal lands. The FPC's license for Project No. 350 stated:

Whereas, by Act of Congress approved June 10, 1920 (41 Stat., 1063), designated therein as "The Federal Water Power Act" and hereinafter called "the Act," the Federal Power Commission, hereinafter called "the Commission," is authorized and empowered, inter alia, to issue licenses for the purpose of constructing, operating, and maintaining dams, water conduits, reservoirs, power houses, transmission lines, or other project works necessary or convenient for the development, transmission and utilization of power across, along, from or in any of the navigable waters of the United States, (including the Territories), or for the purpose of utilizing the surplus water or water power from any Government dam.

The only land AL&P purchased for the project was 161.42 acres from homesteader William S. Myers because the power plant tailrace ran through his property. The land was purchased in June, 1929 for \$1,500.⁴⁴ Apparently it was purchased after Myers was convicted for the murder of AL&P employee Matthew Murphy, in March of 1929. Arrangements were made before the incident occurred to facilitate incursion of the tailrace through the property. What arrangements were made is unknown. The power-

⁴¹ 'Council Approves Power Line Lease' Anchorage Daily Times, 30 June 1928.

⁴² 'Poles are Ready for Heavy Cable: Linemen at Work' Anchorage Daily Times 27 June 1928.

⁴³ Series 7E, Folder 1, Box 19. Frank M. Reed Sr. Papers, UAA.

⁴⁴ Warranty Deed between W. S. Myers and AL&P. Filed June 10, 1929. Precinct Book 12, Page 327. Alaska State Records

house was built just off Myers' property line, on land reserved for the project by the FPC.

The legal description of the land purchased from William Myers was:

Seward Meridian, Alaska
 E2, NW1/4, SE1/4
 S2, SE1/4, NE1/4
 S2, N2, SE1/4, NE1/4
 NE1/4, SE1/4
 Section 19
 and SW1/4, NW1/4, Lot 3
 Section 20,
 Township 16 North, Range 1 East

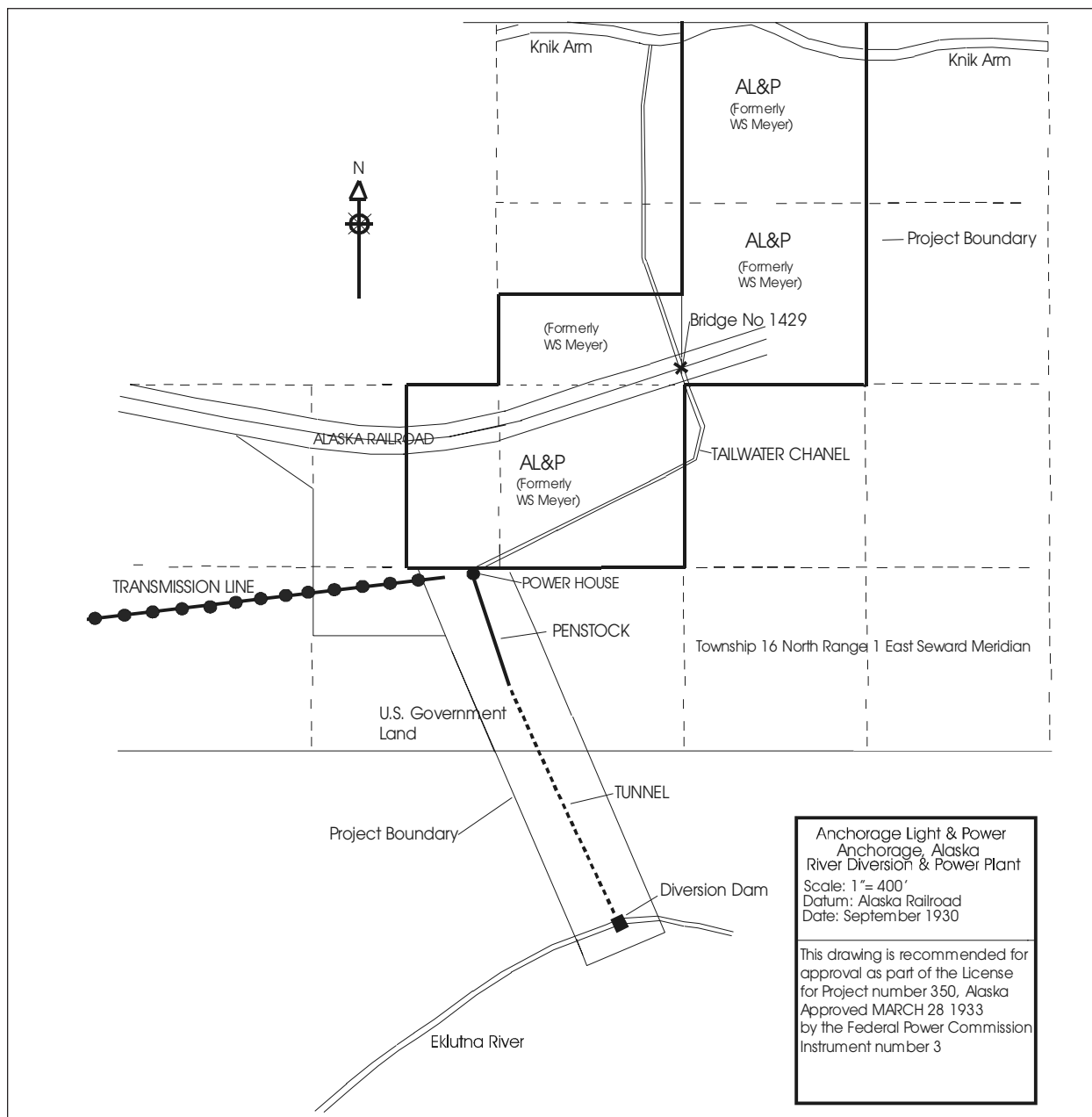

Map 2. Project Boundaries

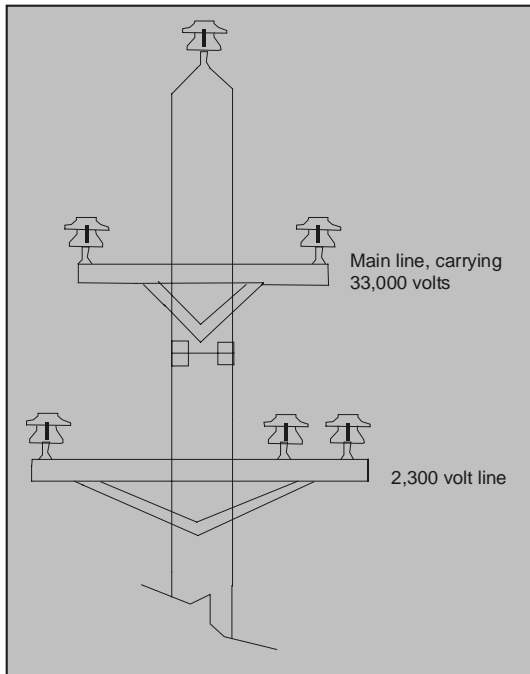

Figure 6. Example of standard pole. AL&P Transmission Line Details. From National Archives, Pacific AK Region, APA, Box 42.



Figure 7. Frank I. Reed standing at a pole on the completed transmission line in December 1928.

6.3 Building of Transmission Line

With an assured power market, construction plans, and money to finance the venture, AL&P was ready to begin construction of the Eklutna hydroelectric power plant. It was a large undertaking and required substantial organization, management and planning. Building a transmission line from Anchorage to Eklutna was the first step needed to supply electricity from the AEC's plant to power construction activities at Eklutna. Once the project was completed, the current would be sent over the line in reverse direction. Construction of the transmission line began on September 27, 1928, and was completed just three months later. Work was carried out at top speed so that the rest of the project could get under way.

Laborers began at the Anchorage end of the line and worked towards Eklutna. The first step was to survey the route. Behind the surveyors came clearing crews to remove trees and brush to create a pathway through the wilderness, a feat that “was no small task in itself where the survey passed through heavy timber growth.”⁴⁵ Fol-

lowing the clearing crews were the post-hole diggers. They used a mechanical post-hole digger when conditions permitted. In inaccessible areas the crew dug holes by hand. The poles were to be placed in the ground at a depth of six or seven feet.⁴⁶ Next, the poles had to be moved to each point along the 26-mile transmission route. In all, the line required the use of about 600 poles. A pole was placed every 240 feet along the route—22 poles per mile.

The transmission line route was mapped out as close to the railroad as possible. This eased transport of the poles. Any other alignment would have required expensive and time-consuming transport issues because of lack of roads. As it was, construction of the transmission line took up to 60 men and 30 horses.⁴⁷ The poles, 40 to 50 feet in length, were transported on railroad flat cars and pushed off at each location. They were then hauled from the railroad tracks to the line location. According to Frank M., “They had a gas cat and they used that in some places, and they used brute strength and stupidity in other places, they just picked it up — 6 or 7 or 8 men would get on it and carry it to the location.”⁴⁸ In other spots, horses were used to move the poles. Half of the poles were cedar and half were native spruce, which

⁴⁵ “Actual Construction Work on Eklutna Power Project Will Commence Next Week,” *Anchorage Daily Times*, 11 Sept. 1928.
⁴⁶ Frank M. Reed Sr., personal interview with author, 10 April 2001, p. 4.
⁴⁷ “Building of Transmission Line Established Records for Speed: Work Completed in 90 Days,” *Anchorage Daily Times*, 21 Sept. 1929, p. 10
⁴⁸ Frank M. Reed Sr., personal interview with author, 10 April 2001, p. 4.



Figure 8. Insulator. Photo by K. Hollinger. 4 Sept. 2001.

were supplied by the James Campbell Company of Anchorage. The cedar poles were shipped from Seattle. The butts of the poles were treated with Anaconda Wood Preservative, the main ingredient being arsenic, to protect them from decay.⁴⁹

The poles were erected within 50 days. At one point, a second crew was brought in to work from the Eklutna end of the line towards the crew coming from Anchorage.⁵⁰ Every possible effort was made to put the line up as quickly as possible. Approximately 15 poles were erected daily until Reed brought in a light derrick in early October, which doubled the installation speed to 30 poles a day.⁵¹ The crew camped on specially equipped Alaska Railroad train cars that were dispatched for power line installation to eliminate travel time from town.⁵²

The last step in the work of the transmission line was fitting the poles with the insulators and cross arms, and stringing Number 4 hard drawn, bare copper wire along the poles. The line was designed for a capacity of 2,000 kilowatts at 33,000 volts. The poles were held in place by standard guy wires where necessary.⁵³ The current was switched on and power sent from the AEC plant to Eklutna at 1:30 p.m. on December 31, 1929.⁵⁴

A second transmission line was built from the power plant to the Eklutna Native Industrial School 1.5 miles from the powerhouse. The main line poles carried the school's 2,300 volt line on a second, lower cross bar to a point .71 miles from the power plant. From there the under-built line branched off to the school.

COLD WORK

Installation of the transmission line was not accomplished at the most ideal time of year. Severe weather conditions likely made work uncomfortable for the men. In a letter to J.L. Dobbins of the Russell-Colvin Company, Frank I Reed wrote, "Yesterday I distributed insulators of the first three miles of line in a very heavy snow storm. Our clothing became so wet that it was very difficult to stay out for the day. Our gloves became wet and frozen and we had to take them off - our hands got so cold they were all swelling."

— Frank I Reed to J.L. Dobbins, 20 Oct. 1928. Personal Collection of Frank M. Reed



Figure 9. Example of number plate on pole. Photo by K. Hollinger.

⁴⁹ "Building of Transmission Line Established Records for Speed: Work Completed in 90 Days," *Anchorage Daily Times*, 21 Sept. 1929.

⁵⁰ "More Men Added To Rush Work on New Power Line," *Anchorage Daily Times*, 26 Oct. 1928, p. 6.

⁵¹ "Eklutna Project Making Progress Along All Lines," *Anchorage Daily Times*, 9 Oct. 1928, p. 8.

⁵² "Actual Construction Work on Eklutna Power Project Will Commence Next Week," *Anchorage Daily Times* 11 Sept. 1928, p. 8.

⁵³ "General Description of Project," *Anchorage Daily Times*, 21 Sept. 1929.

⁵⁴ "Power Line is Completed; Work Starting on Tunnel at Hydro Electric Camp," *Anchorage Daily Times*, 3 Jan. 1929.

There were few people along the transmission line, except for the occasional homesteader. Planners tried to avoid crossing a homestead with the right-of-way. AL&P routed around the Whitney homestead but crossed the southwest corner of Christ Folberg's property. It is not known what arrangements were made to facilitate this incursion. The land for the transmission line was reserved under Section 24 of the FPC's permit. All land lying within 50 feet of the center of the transmission line was reserved for the right-of-way.

6.4 Transportation and Construction Crews

Three main construction areas, spread out over a distance of 12 miles, characterized the project. The first site was Eklutna Lake, where the storage dam was built. Second was the diversion dam site seven miles downstream on the Eklutna River. On the northern abutment of the diversion dam was the starting point of the tunnel through Goat Mountain. Finally, about two miles from the diversion dam was the powerhouse site.



Figure 10. View of construction camp at powerhouse site – note tents, center, left (circa 1928).

Transportation to and within the Eklutna site was a major issue. There were no roads to Eklutna, and the only means of access was by railroad. A 2,300-foot rail spur, called Reed's Siding, was built to the site. All equipment was shipped from Anchorage by rail. Such a large construction project necessitated tons of supplies and equipment, both for construction and maintenance of the large crews employed. Moving equipment from Reed's Siding to Eklutna

Lake, ten miles away, and the diversion dam on Eklutna River, two miles away, was a monumental task. Trails were roughed out by the construction crews and were traversed on foot, by horseback, trucks, dogsled, or on a sled pulled by a gas cat. At one point, 31 men and 12 horses were engaged in moving supplies up to the lake.⁵⁵ Frank M. recalls how the problem of moving a pile driver to the lake dam site was solved:

When they built the first dam at the lake, they needed a pile driver, and they hauled in the building materials by horse train. But the pile driver, the hammer, was too big, too heavy to haul—so they flew it in. It was too heavy for the then existing airplanes; they had to cut the hammer in two. Which they did, and then they had to fly welding equipment in to weld it back together again when they got it back to the lake. There are ways around the lack of infrastructure. Sometimes pretty difficult, but they can do it!⁵⁶

⁵⁵ "Poles are ready for Heavy Cable: Linemen at Work," *Anchorage Daily Times*, 13 Nov. 1928, p. 4.

⁵⁶ Frank M. Reed Sr., personal interview with author, 30 April 2001, p. 7.

Two electric hoist-operated trams were installed to haul supplies up the hill from the railroad spur and down to the diversion dam. Installing the diversion dam tram was difficult in its own right, as men had to be tied to the steep canyon wall while doing the work.

The isolation of the Eklutna project site and its long distance from Anchorage required construction crews to live on the site rather than commute from town. A company construction camp was built to support the workers during peak construction periods. This camp was built to accommodate 60 men and included bunkhouses, tents, garages, a mess hall and a warehouse with bathhouse and offices. A water system with steam-heated water lines was installed. Other equipment at the site included a sawmill, boars, several gas cats, a blacksmith shop and cement mixer.⁵⁷

The Jasper-Stacy Company of San Francisco was awarded the contract for general construction of the project. Jasper-Stacy was an engineering company specializing in civil, mechanical, mining and electric engineering consultation and construction. The bulk of the Eklutna work was supervised and directed by engineer Harold Woods.⁵⁸ Woods was an associate of Fred H. Tibbetts, a leading California engineer. Tibbetts designed the technical details and plans for the Eklutna plant in San Francisco. Besides the supervisory engineer positions, the majority of labor for construction work was recruited locally. Though heavy equipment was brought in from outside, it was “the policy of those in charge of the work to purchase locally everything that it (was) possible to obtain here.”⁵⁹

6.5 Project Components

6.5.1 Tunnel

After the transmission line was installed, work began simultaneously at the lake and the diversion dam site. One of the most time-consuming aspects of construction was the excavation of the 1800-foot tunnel through Goat Mountain. The tunnel was used to channel water from the right abutment of the diversion dam to the penstock on the other side of the mountain.

This tunnel was seven feet wide, eight feet high and dropped 16.2 feet along the end of its course. It was cut out of bedrock with Ingersoll Rand air drills, and exhaust fans had to be installed in the tunnel to keep fumes under control during construction. Several five-man shifts, working around the clock, dug approximately 15 feet per day. Work began at the end of December 1928 and, by April 1929, two thirds of the tunnel was complete.⁶⁰ By mid June, workers were ready to break through the end of the tunnel, and members of the Anchorage City Council were invited to witness this final breakthrough.⁶¹

Most of the tunnel length was unlined, except for the last 70 feet that were lined with concrete and the intake structure that was built with reinforced con-

⁵⁷ “Poles are Ready for heavy Cable; Linemen at Work,” *Anchorage Daily Times*, 13 Nov. 1928, p. 4.

⁵⁸ Frank I. Reed to William Timson. 22 Oct. 1928. Personal Collection of Frank M. Reed Sr.

⁵⁹ “More Men Added to Rush Work on New Power Line,” *Anchorage Daily Times*, 26 Oct. 1928.

⁶⁰ “Work at Eklutna Moving Steadily; Lake Dam Ready,” *Anchorage Daily Times*, 20 April 1929, p. 5.

⁶¹ “Power Tunnel is Near Completion; Finish Tomorrow,” *Anchorage Daily Times*, 20 June 1929, p. 4.



Figure 11. Diversion dam in canyon on Eklutna River – tram on right. Courtesy of National Archives, Alaska Region, APA, Box 42.



Figure 12. Upstream face of diversion dam under construction.

crete and steel. The terminus of the tunnel was protected by a 100 square-foot trash rack to keep debris out of the penstock. The concrete reinforced valve house at the end of the tunnel contained a 54-inch diameter butterfly valve that could stop the water flow for emergency repairs and yearly maintenance.⁶²

6.5.2 Diversion Dam

While the tunnel was the most time-intensive aspect of the project, building the diversion dam proved the most dangerous. The dam is located on the Eklutna River approximately eight miles downstream of the lake. Its location in a steep-sided canyon made construction work very precarious. Both sides of the canyon next to the diversion dam were stripped of vegetation for safety reasons. Workmen also tried to clear the walls of loose material, yet there were still occasional rock falls endangering those laboring below.⁶³

The purpose of the diversion dam was to divert water from the natural Eklutna River channel into the tunnel through Goat Mountain. The dam was a large concrete arch structure 61 feet high and 98 feet long on the crest.

It was eight feet thick at the base and 5 feet thick at the crown. The spillway at the top was designed to allow passage of 6,000 cubic feet of water per second through 73 feet of clear space.⁶⁴ A sluice gate was built into the bottom of the dam to allow gravel and debris deposits to be released downstream. 1948 studies estimated that, on average, 300,000 cubic yards of sediment were removed from behind the dam every year. Trees occasionally got stuck in the gate during sluicing operations, and had to be shot out.⁶⁵ A catwalk supported by piers was built over the spillway in 1933 at the request of the Federal Power Commission.⁶⁶

The dam foundation on the riverbed floor was excavated with jack hammers and paving breakers powered by an Ingersoll Rand

⁶² Record Group No. 447, Box 42, File: Fair Market Value and Severance Damages applicable to Hydroelectric properties and rights of city of Anchorage, Alaska. December 1952. History and Description of the Property. p. 9. National Archives, AK Region.

⁶³ Harold I. Wood. "General Description of Power Project of the Anchorage Light & Power Co." 1929. Personal Collection of Frank M. Reed Sr.

⁶⁴ History and Description of the Property. National Archives - Pacific Alaska Region, Record Group No. 447. pp. 8, 9.

⁶⁵ Joseph M. Morgan. *Eklutna Project to Serve 25% of all Alaskans*, p. 28.

⁶⁶ President's Annual Report, 1933, Anchorage Light and Power Company. Personnel Collection of Frank M. Reed Sr.



Figure 13. Catwalk installed on diversion dam in 1933 at request of FPC. Courtesy of National Archives, AK Region, APA Box 42.

portable air compressor. The foundation and canyon walls were grouted through drill holes 10 feet deep and spaced 10 feet apart. The cement was grouted under air pressure of 80 pounds per square inch. 1,300 cubic yards of concrete (3,000 p.s.i.) were used in the dam. The design of the dam placed a maximum stress of 400 pounds per square inch on the concrete at a time. The concrete was poured in temperatures ranging from 20 degrees below zero to twenty-six above.

Abutments were gravity type and anchored on solid rock. The upstream face of the dam was waterproofed with Inertol.⁶⁷

6.5.3 Storage Dam

A storage dam on Eklutna Lake proved to be the most problematic construction phase. The storage dam was required to increase the lake's water holding capacity. Initially, a 14-foot high, 240-foot long earthen dam was built on a moraine left by retreating glaciers. This moraine created the lake originally. However, the structure collapsed before the plant went on line.

TOWN EXCURSIONS

To promote the Eklutna project and give curious Anchorage citizens a chance to view the facilities, two public trips to Eklutna were organized. On May 27, 1929, 165 people took the train to view both the hydroelectric project and the Eklutna Industrial School. According to the Anchorage Daily Times,

The day proved a thoroughly enjoyable one, the visitors finding a cordial welcome both at the power camp and at the school. The excursion was one of the most enjoyable ever conducted by the Alaska railroad and the number enjoying the outing undoubtedly would have been very much larger but for the threatening weather.

The train left Anchorage at 9:30 a.m. and returned at 4:00 p.m. The railroad charged \$1.50 per person, with children under 12 at half price. The sightseers brought packed lunches and were served all the hot coffee they could drink at the power plant's mess hall, providing they brought their own cups to drink it with! Construction was nearing completion and the visitors found a camp bustling with work. Most hiked from the powerhouse out to the diversion dam site, nearly two miles away. The dam was viewed from the top of the canyon, with many people leaning over the cliff and hanging carefully onto trees in order to get a better view.

The second excursion was organized after construction was nearly completed in September of 1929. Two hundred and ninety people availed themselves of the opportunity to visit the power plant on this trip. Again, a stop was made at the Eklutna Industrial School. A five-coach train left Anchorage at 11:00 a.m., arriving at the plant an hour later. Everyone hiked out to the diversion dam. A few brave souls climbed down the long ladder into the canyon for a closer look at the dam—a risky undertaking since rain had made the ladder quite slippery that day. The trips served a publicity function for the Anchorage Light and Power Company.

Sources:

- "Excursionists Inspect Great Power Project," *Anchorage Daily Times*. 27 May 1929, p.5
- "Many Enjoy Trip to Eklutna Camp; See Power Plant," *Anchorage Daily Times*. 23 Sept. 1929.

⁶⁷ "General Description of Project," *Anchorage Daily Times*, 21 Sept. 1929, p. 9.



Figure 14. Eklutna Lake spillway, discharging 1,500 cubic feet of water per second. July 7, 1929.

ing protruded three or four feet above the water surface. As the lake capacity decreased during dry periods of the year, sections of the piling could be removed to allow water over the spillway.⁶⁹ These rather costly temporary structures were used until 1941 when a new concrete reinforced rock and earth fill dam was built.⁷⁰

According to a report written in 1940 by Consulting Engineer Anton Anderson:

The original dam was made on top of the glacial muck with brush, clay, moss, logs, lumber and rocks. When water in the lake raised four or five feet, it was found that the slightest leaks under or around the dam dissolved the glacial muck and soon allowed the lake flow to escape.⁶⁸

After the failure of the dam, AL&P put in interlocking wood piling 12 to 16 feet below the lakebed foundation. The top of the piling protruded three or four feet above the water surface. As the lake capacity decreased during dry periods of the year, sections of the piling could be removed to allow water over the spillway.⁶⁹ These rather costly temporary structures were used until 1941 when a new concrete reinforced rock and earth fill dam was built.⁷⁰



Figure 15. Penstock construction in background behind powerhouse. Note railroad spur in foreground, which was removed after construction was completed.

6.5.4 Penstock

The penstock, the tube connecting the tunnel to the power plant, was 847 feet in length and 54 inches in diameter. It was installed at a vertical slope, allowing water channeled through it to fall a distance of 216 feet. The penstock and tunnel were installed to provide a combined vertical falling distance, or head, of 232 feet. The penstock terminated in a Y shape, with a separate branch leading to each generating unit.⁷¹ A steel plate sealed the west portion of the Y until the second turbine was installed in 1935. The penstock was buried in the ground at a minimum depth of three feet and secured in place with six reinforced concrete piers. The pipe was asphalt-dipped and soil-proofed with an asphalt-saturated felt.⁷²

⁶⁸ Joseph M. Morgan, *Eklutna Project, to Serve 25% of all Alaskans*. p. 27.

⁶⁹ *Ibid.* p. 28.

⁷⁰ There is a discrepancy between oral and written documentation regarding the date that the new storage dam was built. According to Frank M. Reed Sr., it was constructed in 1935. Several written sources state that it was built in 1941 including: "History and Description of the Property," National Archives, Pacific AK Region, Record Group No. 447, AK Power Administration. Box 41 of 67.

⁷¹ Joseph M. Morgan, *Eklutna Project, to Serve 25% of all Alaskans*, p. 9.

⁷² Harold I. Woods. "General Description of Project," *Anchorage Daily Times*, 21 Sept. 1929, p. 9.



Figure 16. AL&P powerhouse as it appeared with lean-to addition added in 1935 and the relocated transformers to left. Courtesy of National Archives.

PELTON WHEEL

The Pelton Wheel was invented by engineer Lester Allen Pelton in 1880. This common type of impulse turbine uses the kinetic energy of water pressure to turn its wheel. Buckets or cups located around the circumference of the wheel are rotated by water directed through one or more confining nozzles. The water is forced through the nozzle under pressure created by the head conditions (vertical distance that the water falls) Pelton Wheels may be used in most high head installations. They are adaptable to variable flow rates by adjusting the size of the nozzle opening, or the number of nozzles in use.

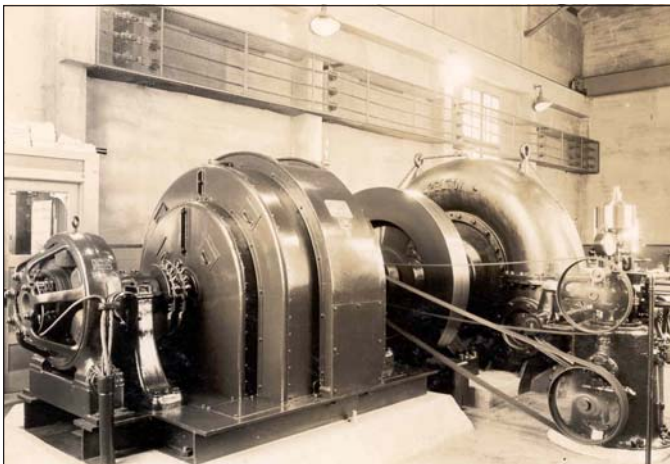

Figure 17. Pelton Wheel, interior of powerhouse.

6.5.5 Powerhouse

The powerhouse, a concrete reinforced building, was used to shelter generating equipment from the elements. The building, 61 by 27 feet, contained a machine shop, storeroom and ferro-clad enclosed control room. It had large galvanized steel-framed industrial windows. A garage entrance was located in the front of the building, underneath a large arched window, and there were several other doors around the building to provide access. The roof was steel trussed with asbestos shingles. There were two concrete lean-to additions attached to the sides of the main structure. The northern lean-to was constructed in 1935 and housed a switchboard and an office. It was removed at an unknown date. The other lean-to was initially used as the switchroom and later as a tool and supply room. It was built at the same time as the main building.⁷³

The power plant housed a 1,500 horsepower Pelton Wheel water turbine and a standard General Electric 1000 kW generator. The turbine rotated at 720 r.p.m. (revolutions per minute). Identical turbine and generator units were installed in 1935, doubling the generating capacity of the plant. The Pelton Water Wheel Company supplied and installed the turbine governor, relief valve and butterfly valves. The General Electric Company provided the generator, exciter and switchboard.⁷⁴

The interior of the building was serviced by a 6-ton capacity, hand-operated crane that traveled the length of the building and was used to move heavy equipment. The exterior grounds of the powerhouse were floodlighted. The tailrace, a reinforced concrete-lined channel extending from the back of the building, carried water away from the powerhouse and into Knik Arm. Tail water from the draft tube was directed through a separate conduit from the relief valve discharge.⁷⁵ It was problematic at first as the channel was only excavated a short distance from the powerhouse and water was allowed to run

⁷³ National Register of Historic Places Inventory Nomination Form for the Old Eklutna Power Plant. 15 March 1978.

⁷⁴ Harold I. Woods. "General Description of Project," *Anchorage Daily Times*, 21 Sept. 1929, p. 9.

⁷⁵ *Ibid.*

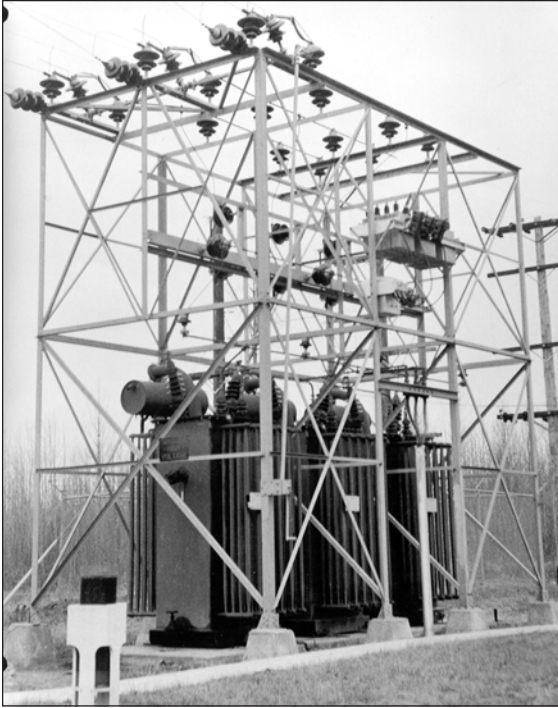

Figure 18. Transformer station adjacent to Eklutna Power Plant. Courtesy of National Archives, AK Region. APA Box 42.



Figure 19. Tailrace extending from rear of powerhouse.

off naturally. It threatened to flood the railroad line, so steps were quickly taken to tunnel underneath the railroad. From there, the water went through a natural slough to Knik Arm.⁷⁶

The transformer station, originally on the east side of the powerhouse, was moved in 1935 when the second Pelton Wheel and turbine units were installed. At that time AL&P was hoping to extend the transmission line north to Matanuska. This plan wasn't realized until 1942, when the Matanuska Electric Association constructed its own line from the powerhouse. The transformer station was a steel bus structure with three 833-kva transformers, an air break switch, three single pole lightning arresters, capacitors, bus and bus insulators. The transformers raised the generators from 2,300 volts to 33,000 volts.

6.5.6 Anchorage Substation

AL&P's transmission line ended at a transformer station built in Anchorage. It was similar to the one adjacent to the powerhouse at Eklutna. The substation was built close to the railroad yards and was connected to the AEC's power plant in case an emergency shutdown of the Eklutna plant necessitated using the railroad's facilities. The substation was the point where the city took over distribution of the electric current to the general population. From there, three feeder lines carried electricity to AL&P's main consumers: the Municipality of Anchorage, the Alaska Railroad, and the Anchorage water pump.⁷⁷



Figure 20. Anchorage substation, 1929.

⁷⁶ Joseph Shaw to Frank I. Reed. 20, 29 Oct. 1929. Personal Collection of Frank M. Reed Sr.

⁷⁷ "General Description of Project," *Anchorage Daily Times*, 21 Sept. 1929.

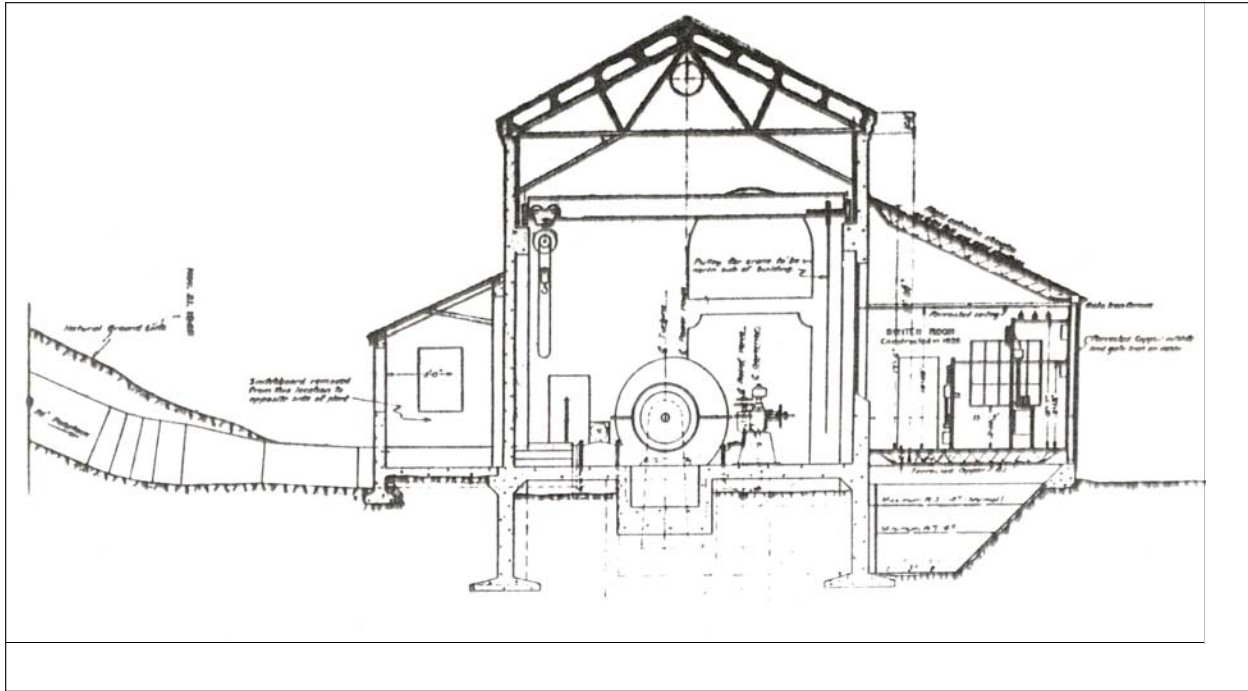

Figure 21. This drawing was approved by the Federal Power Commission by order entered March 14, 1945, as part of the license for project No. 350, Alaska, Issued Nov. 21 1945. From National Archives, AK Region, Alaska Power Administration (APA) files, Box 42.

CHAPTER 7.0 Operations

Power was cut into Anchorage on September 8, 1929. Construction work was not yet completed. Several jobs, such as further excavation of the tailrace channel and backfilling the penstock, continued over the next few months. The major issue that beleaguered AL&P, however, was the storage dam at the lake. According to Frank M. Reed Sr., the dam was built to specifications configured for California weather and soil conditions.⁷⁸ The glacial silt compromising the lake foundation necessitated extra piling placed deeper in the ground.⁷⁹ The initial structure quickly proved unsound. The dam was almost destroyed by flooding in 1929 before the plant ever went on line. The Eklutna Lake dam was a source of continual stress and expense to AL&P board members. Reed was anxious to get the dam rebuilt before the onset of winter. Joseph Shaw, engineer for the Jasper-Stacy Company, quoted a price of \$8,000 for the work. Four months and over \$15,000 later, the job was still unfinished. Friction developed between Shaw and Reed. Reed felt that Shaw was careless and wasteful in his use of time and company funds for purchasing supplies and equipment.⁸⁰ Shaw believed there were not enough resources (money or men) made available for him to complete the project in a timely and economical manner.⁸¹ Discouraged and increasingly alarmed by the mounting costs, Frank I. decided to postpone permanent repairs indefinitely. Temporary restraining structures, expensive in their own right, were used at the lake for many years. In retrospect everyone realized “that it would have been much wiser to have done nothing at all at the Lake during the winter season just past.”⁸²

The Eklutna power plant was finished just before the stock market crashed in 1929. The United States was rocked by a depression throughout the next decade. Nearly every corner of the economy was affected. Though Alaska did not suffer like the rest of the country, there were immediate consequences for the Anchorage Light and Power Company. The line expansions to areas outside Anchorage, which Frank I. Reed was counting on to increase the power

load, became impossible to finance. Russell-Colvin declined to lend AL&P money to build a transmission line to Matanuska. It didn't believe the cost was justified, particularly in view of the fact that the alignment called for crossing Knik Arm and the Matanuska River. These crossings alone constituted a major financial undertaking.⁸³

Meter readings and earnings for December, 1929		
Alaska Railroad	48,4000 KWH @ .04	\$1,936.00
City Pump	22,640 KWH @ .04	\$ 905.60
City of Anchorage	74,550 KWH @ .05	\$3,727.50
Eklutna School		\$75.00
TOTAL		\$6,644.10

⁷⁸ Frank M. Reed Sr., personal interview with author, 15 June 2001, p. 4.

⁷⁹ Joseph Shaw to Fred Tibbetts. 24 Sept. 1929. Personal Collection of Frank M. Reed Sr.

⁸⁰ Frank I. Reed to J.L. Dobbins. 17 Feb. 1930. Personal Collection of Frank M. Reed Sr.

⁸¹ Joseph Shaw to Anchorage Light and Power Company. 20 Oct. 1929. Personal Collection of Frank M. Reed Sr.

⁸² Russell-Colvin Company to Frank I. Reed. 19 March 1930. Personal Collection of Frank M. Reed Sr.

⁸³ Letter from J.L. Dobbins to Frank I. Reed. 11 March 1930. Personal Collection of Frank M. Reed Sr.

Besides halting plant expansions, the depression affected AL&P by making new business startups difficult to back. Reed was hoping that the additional supply of cheaper power would encourage more business; a hope shared by the community. Unfortunately, the depression effectively stopped this development.

At the same time, Russell-Colvin was experiencing its own financial difficulties. In 1930, the company was forced to dissolve due to having extensive frozen assets.⁸⁴ AL&P still owed Russell-Colvin over \$63,000; money it simply did not have at that time. To prevent the stock going to the open market, Reed worked out a payment arrangement with the receiver. Consequently he amassed approximately 60% of the company's stock over the years. One condition of this arrangement was that operating costs of the plant be cut to the absolute minimum.⁸⁵

HOW IT WORKED

Water from Eklutna Lake (the level of which is increased by the storage dam) drains out of the basin and into Eklutna River. After about seven miles, the water is diverted from its natural course by the diversion dam into the tunnel through Goat Mountain. The tunnel empties into the penstock (an enclosed tube) on the other side of the mountain. In the penstock, where most of the head is created, the water falls a vertical distance of 216 feet along its course. The penstock terminates at the powerhouse in a Y shape, with a separate branch leading to each turbine unit. The water hits the Pelton Wheel with enough force to move it at 720 rotations per minute. The turbines turn the generators and the energy is converted into electricity. After the water passes through the Pelton Wheel, it is channeled out of the powerhouse into the tailrace. The tailrace channel eventually empties the water into Knik Arm. The electricity flows from Eklutna to Anchorage over a 26-mile transmission line. At the Anchorage substation where the line terminates, AL&P's responsibility for the current ends, and the cities distribution system takes over. From there, the current is distributed along electrical lines to the city and private homes.

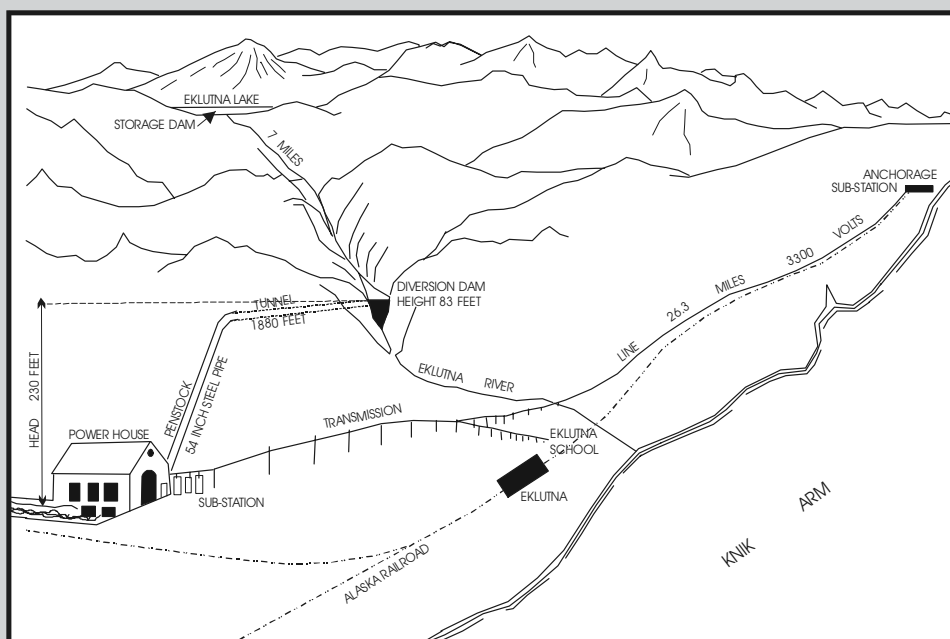

Source: *Anchorage Daily Times*, 21 Sept. 1929

⁸⁴ Ibid.

⁸⁵ President's Annual Report. Anchorage Light & Power Company. 14 Oct. 1930. Personal Collection of Frank M. Reed Sr.

Therefore, during its first few years of business, AL&P was operating under a very tight budget. Reed urged that economy be exercised in every aspect of business. The original operating budget permitted \$1,800 a month for expenses. The amount was immediately cut to \$1000.⁸⁶ Reed went so far as to discourage use of the phone for conducting company business between the Anchorage office and the Eklutna operating crews. After all, the mail ran three times a week!

The depressed condition of the company finances moved Reed to try selling the plant in the early years of its operations. The whole business seems to have put great stress on Reed. At one point near the end of construction he stated, "It certainly will be a wonderful relief when this plant is in operation. Some days I feel that the pressure is so great that if the plant would happen to start off without a few days notice I would almost explode with relief."⁸⁷ Reed stated his motivations for selling the plant as being, "to put the plant in good standing and with finances sufficient to extend the lines into the Willow Creek also with a thought that the Anchorage stockholders would more quickly realize on their investment."⁸⁸ AL&P came close to being sold to Pemberton and Son, Vancouver Investment Bankers, but the deal fell through at the last minute. After a lengthy investigation Pemberton decided that the plant was not in a position to make significant financial gains in the near future. They wrote, "Confidence has declined to a very low level during the last few months as you know, and for that reason it is almost impossible to finance any venture no matter how attractive it is."⁸⁹ Reed gave up on selling AL&P and continued operating the plant, doing everything he could to make it a profitable business.

AL&P opened a store in 1929 as construction neared completion, with the aim of increasing the use of electrical appliances in Anchorage. The store sold and installed ranges, washing machines, and other electrical wares. Located on Fourth and D Street, it was in the same room as the company headquarters. Most products were sold just above cost to encourage energy consumption and long-term profitability for the company.⁹⁰ Reed quickly realized that the store was a serious financial drain on the company. There were only so many people in town and another electric store was already in business. Operations were cut to the bone.⁹¹ The full-time shopkeeper was let go and the general maintenance man took over part-time sales and installation of equipment on an as-needed basis.

Reed worked several angles over the years, trying to increase the power load. He tried purchasing a tract of birch timber, hoping to start a furniture business or a pulp mill, but his application was unsuccessful. In his application Frank wrote his reasons for wanting the timber:

The principle object and purpose for which the said hydro-electric plant was constructed was the development of the resources of the territory in the vicinity of Anchorage, it being readily un-

⁸⁶ Ibid.

⁸⁷ Frank I. Reed to J.L. Dobbins of Russell-Colvin Company. 30 May 1929. Personal Collection of Frank M. Reed Sr.

⁸⁸ Frank I. Reed to Pemberton & Son Vancouver Limited. 21 Dec. 1931. Personal Collection of Frank M. Reed Sr.

⁸⁹ Pemberton & Son Vancouver Limited to Frank I. Reed. 5 Dec. 1931. Personal Collection of Frank M. Reed Sr.

⁹⁰ President's Annual Report. Anchorage Light & Power Company. 14 Oct. 1930. Personal Collection of Frank M. Reed Sr.

⁹¹ Frank I. Reed to J.L. Dobbins of Russell-Colvin Co. 17 Feb. 1930. Personal Collection of Frank M. Reed Sr.

COOK WITH ELECTRICITY

The Anchorage Light and Power Company will be ready next week to install Electric Ranges, Washing Machines, Hot Water Heaters, Bath Room Heaters, Portable Air Heaters Samples of Electric Ranges and Heaters from which selections can be made are on exhibition at our booth in the Fair Building

With the new cheap rate for electric energy for domestic purposes the installation of Ranges and Heaters will make housework easier as well as well as more economical

THE ELECTRIC MAID FREES THE MODERN MOTHER
IT WORKS WITHOUT PAY while MOTHER IS AT PLAY

	<p>The Electric Way Is the Economy Way</p>		
	<p>A Complete Array of Utensils</p> <p>The home that is well equipped with Electric Utensils is the home of happiness and economy. Electric Utensils save hours of labor, do the work much better, yet the cost of operation is negligible</p>	<p>Make Housework Easier Try the Installation of a WASHING MACHINE</p>	<p>Now Every Home Can Have An Electric Range</p> <p>Enjoy the convenience, cleanliness, coziness and economy of electric cooking. You can secure one of these Hotpoint Electric Ranges on an easy payment plan if desired, or at a discount for cash.</p> <p><small>These new Ranges are complete—three unit cooking top and large oven—yet are so compact they are ideal for apartments and homes with small sized kitchens</small></p>

Figure 22. This full page ad appeared in the *Anchorage Daily Times* frequently throughout mid September, 1929 as construction of the Eklutna Power Project neared completion. *Anchorage Daily Times* 14 Sept. 1929.



Figure 23. Original Anchorage Light and Power Co. office on 4th and E. The office was moved to the Masonic Building in 1932 or 1933.

derstood that without cheap and ample power, no major development could be undertaken nor effectually carried out. It is just as important now that cheap and ample power is available that a market for the power be developed, and it is with this in view that my application to purchase timber is being made.⁹²

In 1931 Reed contracted with the U.S. Army Signal Corps to provide power to its broadcasting and receiving station. The Signal Corps, later named the Alaska Communications System, was set up in 1900 to provide telegraph and cable lines to link the Department of Alaska Headquarters with remote Army posts. Both the military and civilians used the system.⁹³ The contract resulted in additional monthly revenue of approximately \$200 for AL&P.⁹⁴ It was a constant battle to keep costs down and maintain some semblance of profitability for the company.

In 1935 conditions in Anchorage improved somewhat. The Matanuska Colony, a federal farming relief project, began and it was rumored that a large military base was in the works. That year the second Pelton Wheel and generating unit were installed in the powerhouse, doubling the plant's capacity. The

increased power demand can likely be attributed to Anchorage's modest population growth and development during the mid 1930s.

In 1935 Reed also decided to put in a better road from Eklutna Lake to the powerhouse. AL&P borrowed a grader from the Alaska Road Commission and started clearing the way. According to Frank M., the grader was not in very good condition, nor was it meant to be used in such rough terrain. Nevertheless, several men started clearing a right-of-way and leveling the ground. The Alaska Road Commission eventually took over the work and finished the road. That year Reed also purchased a Washington Iron Works 1,500 horsepower diesel generator and installed it at Anchorage. It was used to provide backup power in case of an emergency plant shutdown or line complications.⁹⁵ The Anchorage substation was expanded to house the large generator.

Alaska began bolstering its defense infrastructure in 1940. Executive Orders 8102 and 8343 were issued—withdrawing 45,939 and 40,563 acres of land respectively for the establishment of Fort Richardson. Construction began on June 8, 1940, and continued throughout the winter. Anchorage would never be the same as people flooded into the area at an unprecedented pace due to

⁹² The Application of Frank I. Reed to Purchase Birch Timber. U.S. Land Office, Anchorage Alaska. Serial no. 07431. 16 Dec. 1929. Personal Collection of Frank M. Reed Sr.

⁹³ Truman R. Strobridge. *Strength in the North: A History of the Alaskan Command 1947–1967*. (Elmendorf AFB, Alaska, 1966) p. 70.

⁹⁴ President's Annual Report. Anchorage Light & Power Company. 14 Oct. 1930. Frank M. Reed Sr. Papers. UAA.

⁹⁵ Frank M. Reed Sr., personal interview with author, 10 April 2001, pp. 3, 8. reconstructed in 1941.

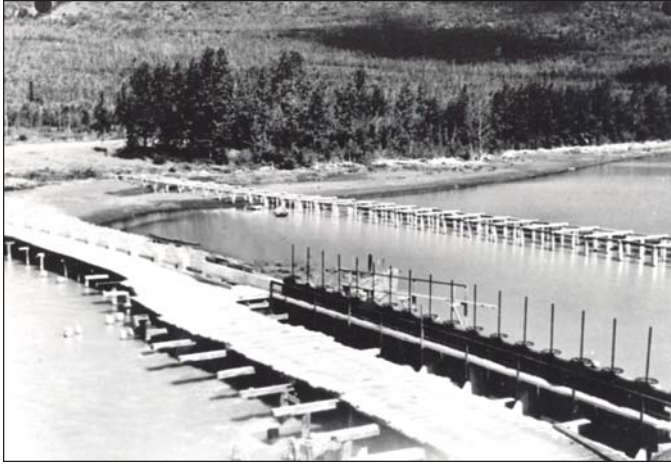

Figure 24. "General View of Eklutna Dam, Weir, Headgates and Breakwater." National Archives, Pacific AK Region, Box 42, Historical Files and Photo Collection, 1948–1998.

the military buildup.⁹⁶ Frank I. tried to finance a plant upgrade to keep pace with the new power demands, but the effort was unsuccessful.⁹⁷ A few essential changes were made that year as the plant started operating at 100% capacity. A permanent road was built from the powerhouse to the lake, 8 1/2 miles away, to provide easier access for monitoring the water supply. Telephone lines between the powerhouse and lake were also installed for the same reason.⁹⁸

1941 was also a very busy year for AL&P as approximately \$84,000 was spent on various projects.⁹⁹ First, a section of the transmission line on what is now Fort Richardson

had to be relocated. The relocation was done at the request of the War Department to avoid a proposed runway under construction. An amendatory application to the FPC was filed on March 25, 1941, for the line reposition. The area involved began at the E1/2 SE1/4 section 24, township 14, range 3W, running in a southwesterly direction for approximately seven miles to a point on the SE1/4 SW1/4 section 8, township 13N. Range 3W.

Then in 1941 AL&P built a new storage dam at Eklutna Lake. Increased and more reliable water storage became crucial as the plant was suddenly block-loaded most of the time. The new dam, constructed with wood and steel pilings, was a 360-foot long, 8-foot high earth and rock fill structure. A gate controlling water flow into the river was fitted with 19 hand-operated head gates. Fifteen open bays spaced ten feet apart could be flash boarded to increase the holding capacity.¹⁰⁰ The old storage dam was left intact and served as a woodpile breakwater to control wave action.¹⁰¹

Finally, on October 14, 1941, AL&P entered into a contractual agreement with the Matanuska Electric Association (MEA). MEA, a co-operative financed by the Rural Electrification Administration (REA), was formed on March 1, 1941, and established to provide power services to the increasingly populated Matanuska Valley area, which began experiencing significant growth with the introduction of the Matanuska Colony farmers in 1935. AL&P agreed to provide a maximum of 250 kWh to MEA. The line from the powerhouse to Palmer was installed in 1942. MEA financed the transmission line through a low interest (2.46%) loan provided by the REA.¹⁰² AL&P sold power to MEA at two

⁹⁶ *Installation Commander's Annual Real Property Utilization Survey*. 1985. 172D Infantry Brigade (Alaska) Fort Richardson. p. 5-1.

⁹⁷ Frank M. Reed Sr., personal interview with author, 10 April 2001, pp. 3, 8.

⁹⁸ AL&P Application for Amendment of License, Project No. 350, Alaska. Exhibit M-1, Power Plant Equipment. National Archives - Pacific AK Region, Record Group 447. pp. 1, 2.

⁹⁹ National Archives, Pacific AK Region, Record Group No. 447, APA, Historical Files & Photo Collection 1948 - 1998, "Material on original Eklutna Power Development" Exhibit B, Statement Reflecting Gross Original Cost at May 1, 1952.

¹⁰⁰ Joseph M. Morgan. *Eklutna Project to Serve 25% of all Alaskans*, p. 28.

¹⁰¹ There is a discrepancy between the oral and written documentation regarding the date which the storage dam was reconstructed. According to Frank M. Reed Sr., the storage dam was rebuilt in 1935. Written documents, however, state that the dam was reconstructed in 1941.

¹⁰² *MEA's Pioneers, An History of Matanuska Electric Association*. <http://www.matanuska.com/About/History5.html>

cents per kWh.¹⁰³ The area's electricity needs steadily grew in the coming years with sustained population growth. Though AL&P did not actually construct the transmission line to Palmer, the contract with MEA fulfilled a long-standing ambition of the company to supply power to the Matanuska area.

THE LIFE OF AN OPERATOR



Figure 25. Frank M. and Maxine Reed getting ready to move into their cottage at Eklutna, 1937.

Once the Eklutna power plant was completed little supervision was required. Several operators were needed at the powerhouse to keep an eye on the equipment and take readings. Two operators and one maintenance man lived and worked at the powerhouse initially. The operators worked 12-hour shifts, seven days a week, with occasional relief from the maintenance man. There were three cottages at the site and one general building with a kitchen for visitors. Operators lived on site with their families.¹⁰⁴

In 1937 Frank I. Reed's son, Frank M. Reed Sr., was hired as an operator. He worked for AL&P until 1940. The men alternated 8-hour shifts, seven days a week.¹⁰⁵ Pay was between \$200 to \$250 dollars per month.

Frank M. said problems with plant maintenance were few and far between. "It ran just like a clock...steadier than a clock."¹⁰⁶ Most of the work involved routine, hourly reading and recording of the meters and keeping the machinery greased. At that time, Frank M. was also reporting weather conditions to the Weather Bureau in Anchorage. Unless a problem devel-

oped, there was generally no need to keep a constant eye on the equipment. Reading helped to pass the time, and there was a shop in the building where handiwork could be done.¹⁰⁷

Frank M. recalls a rare instance when power transmission failed due to a problem on the line. In those days there was no high tech equipment or easy way of accessing the remote poles. It was necessary to walk along the transmission line to find where and what the trouble was. Frank walked down the easement towards Anchorage.

"I got down about three miles, and it was hard going, and I came to a pole on top of a hill, and I stopped there and leaned against the pole, because I was tired. The damn pole started to fall over! It had broken off and that was where the short was! And if I hadn't have leaned up against it I would have never seen it. But what happened was it swayed in the wind and it broke and it ran the lines together, running shorts".¹⁰⁸

Life at the power plant was isolated. The Eklutna Industrial School and village, a mile and a half away, were the operator's closest neighbors. The Reeds had good friends there, Paul and Pearl Thompson. Frank and his wife, Maxine, went into Anchorage once a week to shop and visit with family and friends. The road to Anchorage was not heavily traveled. Reed remembers that when traveling back and forth from Anchorage, one was careful to be prepared for an emergency since help was a long way off.

Continued on Page 40

¹⁰³ Joseph M. Morgan. *Eklutna Project: To Serve 25% of all Alaskans*, p. 39

¹⁰⁴ Frank M. Reed Sr., personal interview with author, 10 April 2001, p. 5.

¹⁰⁵ Ibid.

¹⁰⁶ Ibid. p. 15

¹⁰⁷ Ibid. p. 14, 15.

¹⁰⁸ Ibid. p. 3.

THE LIFE OF AN OPERATOR *continued*



Figure 26. Frank M. and Maxine Reed's cottage at Eklutna. This building was used as an office until Frank M. was hired in 1937.

“One time we were invited into Anchorage for a Christmas dinner. And it was black tie and all that good stuff, and so we never, we didn't drive in our good clothes, we always dressed prepared to walk if you had to. And there weren't many places along the road. And if you had to walk, you might have to walk four or five miles to find a place, if anybody was there. And this one time I put my good clothes and stuff in the back because of a pickup. And when I got into Anchorage and changed my clothes, I didn't have my trousers! Rough! So when I went back out [to the powerhouse] and this was about 4 or 5 in the afternoon and there had been a fresh snow on the road, so we were making the first tracks going out, and coming into town. And about four in the morning when we were going back, we were making the second set of tracks. And we got about two miles from the power plant, three miles, something like that, and what do you know — there's my trousers in the middle of the road! I stopped and picked them up.”¹⁰⁹

The power plant was closed down once a year for maintenance. Water flow through the tunnel was closed off, and the machinery was stripped and cleaned. The diversion dam gates were opened, allowing the accumulated debris and gravel to be released downstream. Frank M. said some years there was so much gravel it nearly reached the top of the dam. Men also went into the tunnel with wheelbarrows and hauled out the sand that collected there.¹¹⁰



Figure 27. Cottage interior.

¹⁰⁹ Ibid. p. 8.

¹¹⁰ Frank M. Reed Sr., personal interview with author, 29 Dec. 2000, p. 36.

CHAPTER 8.0 Anchorage and the Eklutna Power Plant

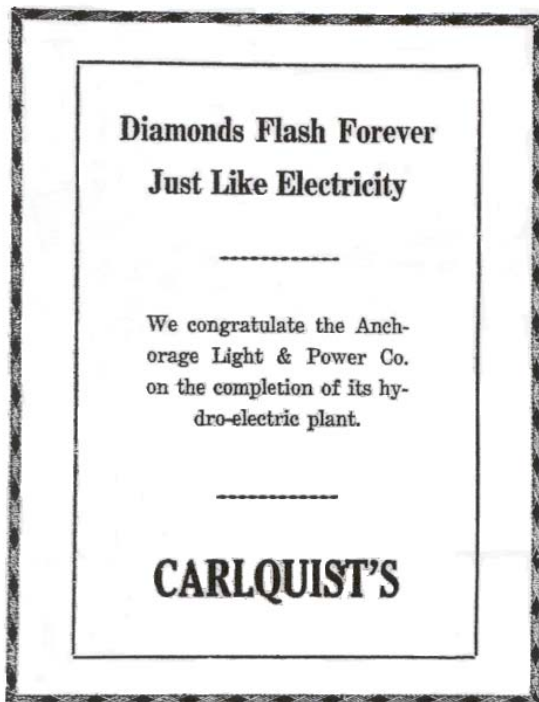

Figure 28. Anchorage Daily Times ad, Sept. 21, 1929.

According to Frank M. Reed Sr., many in the community were skeptical of AL&P's ability to get the power plant built. As the years passed by with still no progress being made, that skepticism escalated. Once the facilities were completed, however, there was general goodwill and enthusiasm towards AL&P and Frank I. Reed specifically. The possibility of extended and cheaper electric service was a development most could appreciate and benefit from personally. Many saw the project as an indication that Anchorage was growing as a city and hoped that business opportunities would grow correspondingly. A 1928 editorial in the Anchorage Daily Times stated,

The announcement yesterday that the Eklutna power project is to become a reality was the best news that has come to Anchorage in years, for it will mean not only cheaper electric light and power rates to Anchorage consumers but will also be the forerunner of new industries here which will increase the business life of the city to a point far beyond the hopes of its most optimistic citizens.¹¹¹

When AL&P finished construction, the Anchorage Daily Times ran a fifteen-page special edition on the Eklutna hydroelectric plant. It detailed the construction and engineering work that had occurred over the last two years. The paper was filled with congratulatory messages to Frank I. Reed and AL&P from almost every business in town. The Times had followed the progress of the power plant's construction throughout 1928 and 1929, publishing several articles on the project each month.

The Eklutna power plant resulted in 20% lower rates of wholesale electricity to the city of Anchorage. Power was sold to the Municipality and the Alaska Railroad at four cents per kWh—except for domestic power for cooking and heating (2.5 cents per kWh) and domestic and commercial light (6 cents per kWh). The city decided to sell the power on to private citizens at a 1-cent profit per kWh, or 3.5 cents.¹¹² The rates were comparable to those paid by residents of Seattle, Washington.¹¹³

Besides the material benefit of cheaper power, the Eklutna plant affected the community in several ways. First, it provided many temporary jobs. The

¹¹¹ "Editorial," *Anchorage Daily Times*, 26 June 1928, p. 1.

¹¹² Agreement between AL&P and the City of Anchorage. 18 July 1927.

¹¹³ "City Council Lowers Rates Lights-Power," *Anchorage Daily Times*, 25 July 1929, p. 1

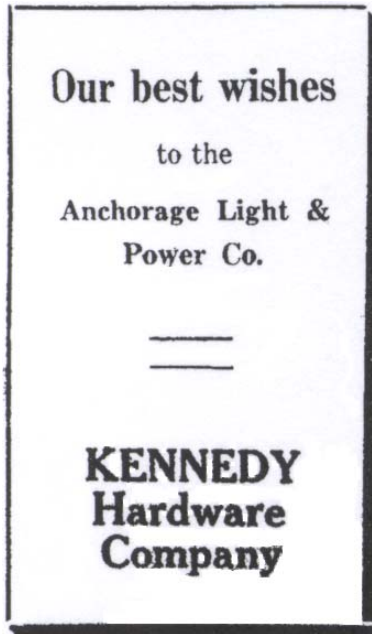

Figure 29. Anchorage Daily Times ad, Sept. 21, 1929.

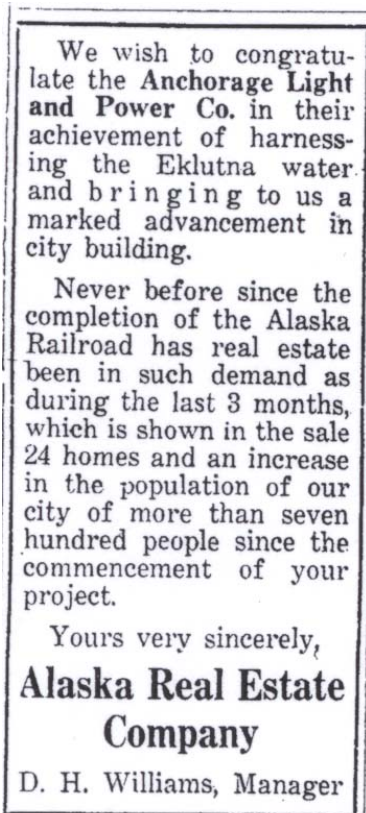

Figure 30. Anchorage Daily Times ad, September 21, 1929.

work took over a year. At times AL&P had more than one hundred men working, and the majority of labor was local. Seven carpenters, two boiler makers for the penstock, the tunnel foreman, and supervising engineers were the only forces brought in from outside.¹¹⁴ In excess of \$750,000 was spent on the project and a significant portion of this money found its way into local hands. Construction work provided direct, if temporary, stimulation to the Anchorage economy. Money was spent on everything from labor, horses, and lumber to food for feeding the large construction crews. Others in the community had a direct interest in the power plant through their investments. Many Anchorage residents were stockholders in the company. They hoped to make a profit through dividends on their stock.

Frank I. Reed's intent in building the power plant (besides personal profit) was to stimulate the Anchorage economy by making power cheaper and more widely available. The initial success of this goal was hampered by the depression. AL&P began enjoying modest profit gains as the community grew in the mid-1930s. This growth and development cannot, however, be attributed to the availability of cheap power. As John Whitehead states, "For nearly 75 years, Alaskans have hoped that the provision of hydroelectric facilities would lead to an expansion of industry. For the most part this has been an illusion."¹¹⁵ Rather it was the military buildup of the 1940s that stimulated the economy. Power resources were hard-pressed to keep up with the extreme rate of growth experienced by the city.

The Eklutna power plant is significant in Anchorage's history as it represents a substantial private undertaking conducted in Anchorage in the early 1920s. In an era dominated by federal projects, Anchorage Light and Power and Frank I. Reed built an independent power plant that served the city of Anchorage for over 25 years. The power plant harnessed resources that were located over 30 miles away from the city. It took years of planning and determination to tap the resource and make it available to Anchorage citizens.¹¹⁶ Further, as the city grew and additional power sources were brought into use, the Eklutna power plant remained the only economical resource in Anchorage. Steam generators were expensive and costs ran "in excess of the average revenue per kilwatt-hour."¹¹⁷

¹¹⁴ Harold I. Woods. "General Description of Project," *Anchorage Daily Times*, 9 Sept. 1929.

¹¹⁵ John Whitehead. *Hydroelectric Power in Twentieth Century Alaska: Anchorage, Juneau, Ketchikan and Sitka*, p. 154.

¹¹⁶ Carberry and Lane. *Patterns of the Past: An Inventory of Anchorage's Historic Resources*, p. 124.

¹¹⁷ Department of the Interior, Bureau of Reclamation. *Eklutna Project: To Serve 25% of All Alaskans*, p. 37.

CHAPTER 9.0 Eklutna Power Plant is Sold to the City

After ten years of slow and steady operations, things took a dramatic turn with the arrival of the military in Anchorage during World War II. The city population, which experienced no significant growth throughout the last decade, exploded. The power plant began operating at full capacity and the money was flowing in. Unfortunately, it was at this time that Reed's health began to deteriorate. Reed was already blind in one eye due to an accident suffered during military service. Glaucoma rapidly claimed the vision of his other eye. Facing the prospect of total blindness, Reed knew he could not successfully continue operating the company. He also realized that major upgrades would soon be required to cope with the city's increasing power demands. Reed's son, Frank M. did not want his father to sell the company, but Reed did not feel his son had the necessary experience to undertake the major fund-raising that expansion necessitated.¹¹⁸ So when the city indicated an interest in buying the plant, Frank I. Reed was ready to negotiate.

It was largely through the personal efforts of longtime Alaskan, William (Bill) Stolt, that the city purchased the Eklutna power plant. Stolt, an electrician, had long felt that the city should own the production system since it already owned the electric distribution system. "Boy we're the guys, the city should buy it before somebody else comes along and grabs it, and why not the city own it?"¹¹⁹ Stolt operated an electrical store in Anchorage, selling appliances and wiring houses for power. He thought the city was not expanding power services to Anchorage citizens fast enough. He said people were consistently telling him they wanted to use electrical appliances and equipment, but there was no electricity available at their houses. According to an interview, it was Stolt's desire for the city to expand electrical services and own the Eklutna power plant that provided his motivation to serve on the city council and later become mayor of Anchorage. Stolt ran for mayor in 1941, won the election, and served as mayor until 1943.¹²⁰

It took Stolt several years to convince the city council that purchasing the Eklutna power plant was good for the city. The council eventually agreed to put a bond issue for the plant purchase to citywide vote. During the years that it took to get the proposition on the ballot, Stolt promoted the purchase idea.¹²¹

On June 28, 1943, Ordinance No. 139 was passed. It called for a special election for the purpose of submitting to the electors the question of whether Anchorage should purchase the Anchorage Light and Power Company. The purchase was to be paid for by the issuance of \$1,250,000 of general obligation

¹¹⁸ Frank M. Reed Sr., personal interview with author, 29 Dec. 2000, p. 7.

¹¹⁹ William and Lily Stolt, interviewed by Steven Haycox & Maureen Cowles, *Anchorage Pioneers Oral History Project*, 9 Oct. 1992. UAA Archives and Manuscripts Dept. p. 34

¹²⁰ *Ibid.* p. 18-61.

¹²¹ *Ibid.*

bonds. The election was held on August 17, 1943, and the proposition passed. Of the 510 votes cast, 328 were “for” and 177 were “against.”¹²² Ordinance #142 was passed, “providing for the terms and conditions of the purchase of the physical assets of the Anchorage Light and Power Company by the City of Anchorage and confirming said purchase and authorizing Council to complete negotiations.”¹²³ Ultimately, the city paid \$1,000,000 for the facilities. On November 3, 1943, AL&P and the city of Anchorage jointly filed a request to the Federal Power Commission for a transfer of the license. The license transfer was approved on March 1, 1944. The Municipality operated the plant under Anchorage Public Utilities.¹²⁴

By the time AL&P was sold, Reed had amassed approximately 60% of the company’s stock. Reed passed away in 1944 soon after the purchase was completed. He was 71 years old.¹²⁵

9.1 Life at the Power Plant: 1943–1955

The city owned the Eklutna power plant from 1943 to 1953. In 1953 the Bureau of Reclamation purchased the plant, and then it was shut down in 1955. The power plant operators lived with their families at the site’s Eklutna camp. With city ownership of the power plant, more money was available to operate the facilities. Frank M. Reed Sr. remembers four cottages at the powerhouse when he worked there from 1937 to 1940. By the mid-1940s there were six cottages, a cookhouse and a bunkhouse. Five families were prominent at the camp between 1943 and 1955. They were the Stevens, Hendricks, Turners and two Lee families, Jack and Jane Lee and Francis and Genie Lee. Jack Lee was the son of Francis and Genie.

Lil and Gene Turner had two daughters: Pat and Gene. Mr. Turner was a mechanic and operator. Mrs. Turner was the camp cook. She prepared meals for the single men living and working at the site. Initially there was a separate cookhouse and bunkhouse for the men. Then the Turners moved into a new, larger house. There were bedrooms upstairs for boarders and a large kitchen for Mrs. Turner to prepare meals.

Mary Ada Peery (Francis and Genie Lee’s daughter, and Jack’s younger sister) recalls that her family lived at the camp from 1941 to 1955. They moved to Alaska from Minnesota in 1935 to join the Matanuska Colony. Francis Lee had a steam engineering degree from the University of Minnesota. He was a plant operator. Mary Ada was home schooled until entering high school. She used to study



Figure 31. Soldiers at diversion dam guard house during World War II. Courtesy of Mary Ada Peery (Lee).

¹²² Minutes of a Regular Meeting of the Common Council of the City of Anchorage, Alaska, Held in the Council Chambers of the City Hall on August 18, 1943. p. 278.

¹²³ Minutes of Regular Meeting of the Common Council of the City of Anchorage, Held on September 29, 1943. p. 287.

¹²⁴ Department of the Interior, Bureau of Reclamation. *Eklutna Project: To Serve 25% of All Alaskans* (Alaska Investigations Office, 1948), p. 38.

¹²⁵ Frank M. Reed Sr., personal interview with author.

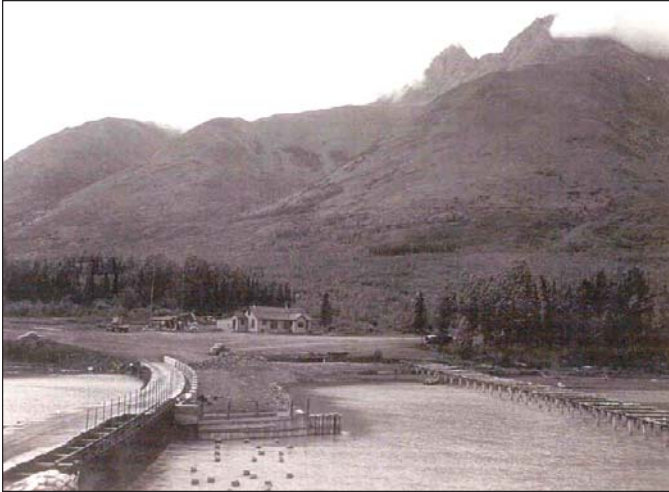

Figure 32. Eklutna Lake storage dam and house that Shackleton family lived in. Courtesy of Mary Ada Peery.

in the powerhouse with her father while he worked.

Mary Ada remembers that during World War II soldiers were assigned to protect the facilities around the clock. They were stationed for the duration of the war at the diversion dam, powerhouse, and storage dam. Soldiers often visited the operators' families to warm up on cold winter days and borrow food.

Eugene and Olive Shackleton lived at Eklutna Lake from 1945 to 1947. They had five children: three boys and two girls. Eugene regulated the storage dam water. He coordinated with the plant operators by telephone to release water downstream as needed. Turning the head gates was difficult during extremely

cold weather. Jane, the eldest Shackleton daughter, married Jack Lee in 1947. Jack Lee was a lineman. Jack and Jane lived in a 23' X 7' trailer for four years until a house was built for them.¹²⁶

Rae Kozlowski and her brother Ken Hinchey spent much of their childhood visiting the camp on the weekends and summer vacations. Their grandparents were Ray and Ruth Stevens. The Stevens lived at the camp from 1946 to 1956. Ray and Ruth moved to Alaska from Oregon for the operator's position. Their son Ken Hinchey Sr. and his family had lived in Anchorage since 1937. During summer vacations Rae and Ken took turns staying at Eklutna as a special treat. Rae remembers that,

Because there was a whole little village living there, with lots of kids, it was like going to camp. We got into some scrapes and had a lot of freedom to roam around that you wouldn't have had in town."¹²⁷

There was plenty to keep a child occupied at the Eklutna camp. In winter the men made an ice skating rink near the powerhouse by using the fire hose to flood an area for the ice. There was also a steep sledding hill behind the camp that was popular with children and adults alike.¹²⁸ In the summer there were picnics, big family dinners and games of hide-and-seek and kick-the-can. Ken Hinchey remembers a salmon run in the tailrace where they caught fish and sold their eggs on the roadside. The children often visited the Eklutna Native Village to play with their friends. Everyone interviewed remembers the Eklutna camp as an ideal place to grow up.

Bears were a fairly constant presence at the camp—largely due to a nearby open dump. Mary Ada used to scare them away with a slingshot. "I don't remember how many confrontations I had with bears. My mother, when she went to take my dad his dinner, she'd make me go chase the bears away. They used to be on our roof!"¹²⁹

¹²⁶ Jane Lee, Pat Leddy and Mary Ada Peery, interview, 26 Sept. 2001.

¹²⁷ Ray Kozlowski and Ken Hinchey, interview, 19 Sept. 2001.

¹²⁸ Jane Lee, Pat Leddy and Mary Ada Peery, interview, 26 Sept. 2001.

¹²⁹ *Ibid.* p. 19.



Figure 33. Maintenance work at the diversion dam. Tram in background. April, 1945. Courtesy of Ray Kozlowski.



Figure 34. Men working on the diversion dam tram. April, 1945. Courtesy of Ray Kozlowski

Carmel Tysver's grandparents were Francis and Genie Lee, and her aunt and uncle were Jane and John Lee. Carmel often visited her relatives on weekends, Christmas holidays and school vacations. Carmel recalls that everyone had gardens and well kept lawns. "And my grandpa had a pig. And I remember getting in trouble because we rode the pig."¹³⁰

The operators worked eight hour shifts six days a week. The shifts were 8:00 am to 4:00 pm, 4:00 pm to 12:00 am, and 12:00 am to 8:00

am. The men rotated shift hours every four weeks. There were also mechanics, linemen and maintenance men working at the camp. Operations were usually routine. The only time things got really hectic was when the military's power sources went off line. Mary Ada remembers:

"Fort Rich was always going off line. Fort Rich and Elmendorf, and they caused major problems for us. All the guys would go dashing over there to throw their switches and balance the thing. I mean, this was a big deal...And they'd usually be able to fix it so it wouldn't go off line."¹³¹

¹³⁰ Carmel Tysver, personal interview with author, 21 Sept. 2001.

¹³¹ Jane Lee, Pat Leddy and Mary Ada Peery, interview, 26 Sept. 2001. pp. 26, 27.



Figure 35. Old cookhouse at Eklutna camp. Courtesy of Mary Ada Peery.

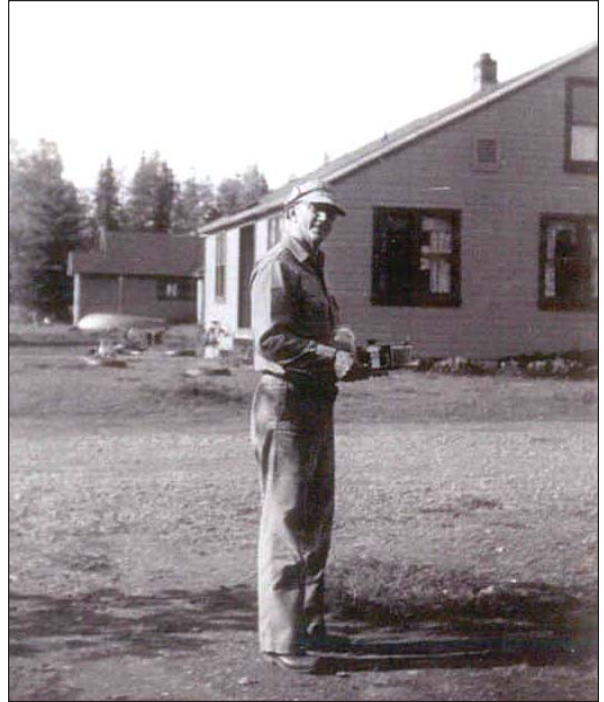

Figure 36. Francis Lee in front of the new Turner house which served as cookhouse and bunkhouse for boarders. Courtesy of Mary Ada Peery.



Figure 37. Jane (Shackleton) Lee. Stevens house and two garages in background. Courtesy of Mary Ada Peery.



Figure 38. Francis, Mary Ada and Genie Lee in front of their house. Courtesy of Mary Ada Peery.



Figure 39. Left to right - Carmel Mohan (Tysver), Jimmy Lee, Mary Ada Lee and unknown in front of Francis and Genie Lee's house. Courtesy of Carmel Tysver.



Figure 40. Mary Ada Lee (Peery) with Jack and Jane Lee's son, Jimmy in front of the Stevens house. Courtesy of Mary Ada Peery.

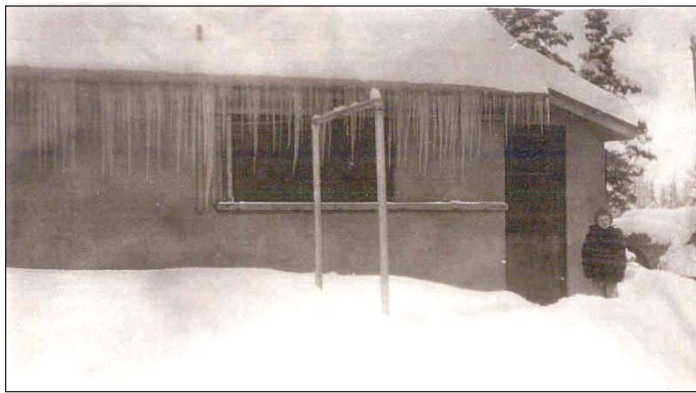

Figure 41. Francis and Genie Lee's house in winter. Courtesy of Mary Ada Peery.

ANCHORAGE OPERATING POWER TIME LINE: 1935–1955

- 1935 _____ Second Pelton Wheel and generator installed at Eklutna Powerhouse, plant capacity doubles to 2000 kW.
- 1937 _____ AL&P purchases standby Washington Iron Works diesel generator and installs at Anchorage.
- JULY 1, 1943 _____ Public election held to determine whether to borrow money to purchase Eklutna power plant. 510 votes cast, 328 for purchase and 177 against. Measure passed.
- AUGUST 17, 1943 _____ Public election held to determine whether to borrow money to purchase Eklutna power plant. 510 votes cast, 328 for purchase and 177 against. Measure passed.
- OCTOBER 25, 1943 _____ City purchase of Eklutna power plant consummated - Price: \$1,000,000.
- 1945 _____ City purchases steam diesel generator.
- 1945 & 1946 _____ City intermittently puts old AEC power plant back on line.
- 1947 _____ City leases, then purchases Sackett's Harbor and connects ship's power facilities to municipal system - 3,500 kW capacity.
- JULY 31, 1950 _____ Public Law 628, 1st Congress, 2nd Session, H.R. 940 authorizes construction of a new hydroelectric power plant at Eklutna.
- 1951 to 1955 _____ Bureau of Reclamation builds new Eklutna power plant.
- Nov. 23, 1953 _____ U.S. Department of Interior, Bureau of Reclamation and city of Anchorage enter contractual agreement No. 14-06-906, for purchase of old Eklutna power plant. Price, \$1,841,760.
- 1955 _____ New Eklutna power plant goes on line - 33,000 kW capacity.
- 1955 _____ Old Eklutna power plant shut down.

CHAPTER 10.0 Anchorage Power Needs Grow

During the city ownership of the Eklutna power plant, Anchorage developed at a phenomenal pace. In 1939, the population of Anchorage was just 4,000 people. By 1941 there were 10,000 in the city.¹³² From 1939 to 1948 the city population increased 570%.¹³³ The Matanuska Valley population, which was still mostly dependent on Anchorage power sources, was also undergoing rapid expansion. The Eklutna power plant was built at a time when the population of Anchorage was around 2,500 people. The most ambitious of developers could not have anticipated the incredible growth that Anchorage would experience.

The military immediately realized the Eklutna power plant could not meet its energy requirements and installed several diesel and steam plants around Fort Richardson. The plants were connected to one distribution system, which in turn was connected to the Eklutna transmission line at a substation on Fort Richardson. This allowed power sharing in the event of an emergency.¹³⁴

The rapid influx of people due to the military buildup stretched city power sources to the absolute limit in the 1940s and 1950s. Rolling blackouts during peak load times were imposed throughout the city. The city leased and then purchased the stern half of an old oil tanker that had broken in half during a storm near Adak. The ship, a WWII Liberty Ship called *Sackett's Harbor*, was equipped with a coal generating power plant with a 3,000 kW capacity—larger than the Eklutna plant's 2,000 kW capacity. At first, the Navy intended to haul the ship near Anchorage waters and use it for target practice. But after its power capabilities became known, locals encouraged the city to use the ship as a power resource. It was brought into Anchorage and outfitted for connection to the municipal distribution system. The ship was used for the next eight years as, “the biggest generating unit in the whole hodge-podge of municipal facilities.”¹³⁵ The arrival of *Sackett's Harbor* marked the end of an era for the old Eklutna power plant. No longer was it the largest power supplier in Anchorage (though it remained the most economical power source until the new Eklutna plant was completed).

Even with the additional energy provided by *Sackett's Harbor*, power shortages were critical. The AEC's old coal plant was intermittently brought back into service, and several diesel generating units were purchased. Electrical demand had far exceeded the combined generating capacity of Anchorage power plants. Upgrades and expansions were no longer an option for the old Eklutna power plant. The city had simply outgrown the facilities.

Recognizing the inevitable, the Bureau of Reclamation began investigating the possibility of building a new, larger hydroelectric power plant at Eklutna.

¹³² A.M. Rollins, *Census Alaska: Numbers of Inhabitants 1792 - 1970* (University of Alaska: Anchorage, 1978).

¹³³ Department of the Interior, Bureau of Reclamation. *Eklutna Project: To Serve 25% of All Alaskans*, p. 41.

¹³⁴ *Ibid.* p. 38.

¹³⁵ “Beloved City Power Facility was Stern Half of Tanker,” *Anchorage Daily Times*, 26 Jan. 1957, p. 11A.

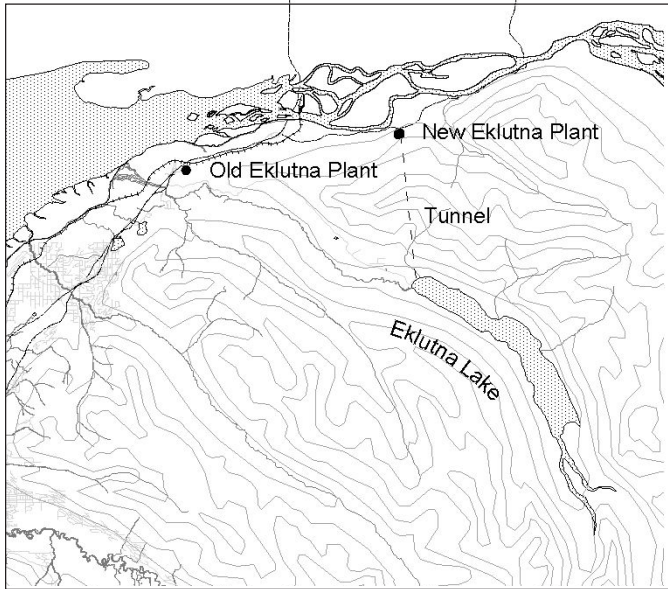

Map 3. New Eklutna Power Plant.

In 1948, a detailed report was completed and presented to the Commissioner of the Reclamation. Submitted by Joseph M. Morgan, Chief of the Alaska Investigation Office, the report concluded that the project was sound and economically feasible. The new Eklutna Power Project was authorized on July 31, 1950, by Public Law 628, 81st Congress, 2nd Session, H.R. 940.¹³⁶

The Bureau of Reclamation determined that there was not enough water to power both the new and old facilities—the old Eklutna power plant would have to be shut down.¹³⁷ The new facilities took water directly through a tunnel on the lake floor, increasing the water storage and head capacity. The Bureau entered into contractual agreement No. 14-06-906 for the purchase of the old plant. The Bureau paid the city \$1,841,760 for the facilities.¹³⁸

Palmer Construction was awarded the contract for construction, and work began in October of 1951. The new plant went on line on July 1, 1955, and is still serving Anchorage. The plant had a 33,000 kW capacity as compared to old Eklutna's 2,000 kW capacity. Interestingly, none of the old Eklutna power plant employees were hired to work at the new plant.

¹³⁶ U.S. Bureau of Reclamation. *Technical Record of Design and Construction: Eklutna Dam, Tunnel and Power Plant* (Denver, 1958).

¹³⁷ Department of the Interior, Bureau of Reclamation. *Eklutna Project: To Serve 25% of All Alaskans*.

¹³⁸ U.S. Bureau of Reclamation. *Technical Record of Design and Construction: Eklutna Dam, Tunnel and Power Plan*.

CHAPTER 11.0 National Register of Historic Places

The National Register of Historic Places was instituted with the National Historic Preservation Act of 1966. The purpose for its creation is to contribute to the identification, evaluation and preservation of important cultural resources in the United States. The National Register is the list of significant historic properties in the United States. As such, it is the national repository of documentation on the variety of historic property types, significance, abundance, condition, ownership needs and other information. It is the beginning of a nation census of historic properties.

A property becomes eligible for inclusion in the National Register if it meets the criteria for evaluation. The criteria are written broadly to allow incorporation of a wide variety of building and property types. The criteria are applied within a property's historic context. Historic context is the time, place and theme during which a property/place was constructed or used. There are four criteria that may then be used to determine a property's eligibility. The property must be associated with one or more of the following requirements:

- A. Associated with events that have made a significant contribution to the broad patterns of our history.
- B. Associated with the lives of persons significant in our past.
- C. Embody the distinctive characteristics of a type, period, or method of construction or that represent the work of a master, or that possess high artistic values, or that represent a significant and distinguishable entity whose components may lack individual distinction.
- D. That have yielded, or may be likely to yield, information important in prehistory or history.

Buildings listed in the National Register must also retain their historical integrity. For a property to retain its integrity it must include most original aspects of location, design, setting, materials, workmanship, feeling and association. Listing in the National Register provides uniform recognition that an area or property is of significance to the nation, state or community.¹³⁹

11.1 Physical Remains

While the outbuildings and operators' cottages have been destroyed or relocated, several key engineering components of the old Eklutna power plant remain. These include the powerhouse, diversion dam, tunnel, the Anchorage substation building that housed the diesel generator and switchroom, and segments of the tailrace and transmission line. The various sheds, garages, and



Figure 42. Pole on Fort Richardson. Photo by R. Sackett, June 2001.

¹³⁹ Kristy Hollinger. *Homesteads on Fort Richardson, Alaska*, p. 47.



Figure 43. Side and rear view of powerhouse. Tail-race remains in foreground. Photo by R. Sackett, June 2001.

other support buildings at the lake and powerhouse were likely destroyed or moved as their condition deteriorated in the mid 1950s and early 1960s. The operators' cottages were sold and relocated. The location and current status of the houses are unknown.

The powerhouse is the most well known remnant of the old Eklutna power plant. It has suffered vandalism in recent years. All windowpanes and doors have been removed or destroyed. Its lean-to addition and all interior fixtures and equipment were removed. All electrical equipment was removed at the time it was shut down. The shell of the building is stable and in fair condition.

The diversion dam on Eklutna River has come to local attention recently. The Native Village of Eklutna is attempting to rehabilitate the river, which has long been used for illegal dumping. As part of their long-term cleanup plan they would like to remove the old diversion dam from the river. Large gravel deposits have accumulated behind the dam that will make removal very tricky.¹⁴⁰ The dam has deteriorated, but it still retains structural integrity.



Figure 44. Front view of powerhouse as it appears today. Note that the left lean-to addition (switchroom) is no longer present. Date removed unknown. Photo by R. Sackett, June 2001.

The Anchorage substation building at 601 Whitney Road still stands. The building housed the diesel generator that was purchased in 1935 and the main switchroom. This was the location where the transmission line ended and AL&P's responsibility for the current ended. Today the building serves as a warehouse for E.J. Bartells, a supplier of products for insulation, refractory and HVAC customers.

The tunnel through Goat Mountain has been sealed off. It was not possible to physically examine the tunnel for this report. It is not known if the penstock still exists.

Substantial segments of the transmission line remain within Fort Richardson's boundaries. Twelve poles were also identified on Elmendorf Air Force Base, close to the Fort Richardson boundary. Aerial survey determined that approximately 80% of the poles on Army land are still extant. The poles examined were generally in excellent condition. The wire was removed from the line except for several poles where

small pieces of the wire remain attached to insulators. Most insulators and cross arms are intact. A metal number plate nailed to the pole approximately five feet from the ground identifies each pole. Numbering began at the Eklutna end of the transmission line with number one. The line is highly distinct and

¹⁴⁰ "River Rehab: Village wants to remove junked cars and other trash and restore salmon runs," *Anchorage Daily News*, 29 May 2001.

easy to differentiate from other poles. The right-of-way has not been maintained, and new vegetation has grown up around the poles in most areas. However, the vegetation is still fairly distinct from mature growth, making the old right-of-way distinguishable.

11.2 Eligibility

Fort Richardson's concern with the old Eklutna power plant is in determining the historic significance of the remaining poles on its property. If the poles are eligible for the National Register, a plan for their management should be developed. Approximately ten miles of the 26-mile transmission line lie on Fort Richardson. Of the ten miles of transmission line, approximately 80% of the poles are still standing. Time and budget constraints did not permit close examination of poles off Fort Richardson or Elmendorf Air Force Base. However, aerial survey determined that a substantial portion of the line still exists in excellent condition—from the east Fort Richardson boundary to a point parallel with Chugach High School. From there, the route coincided with high development areas and the poles were removed. In some places a new transmission line appears along the old route.

In several places on Fort Richardson and Elmendorf, the transmission line right-of-way appears to have been reused for roads. In these areas, poles were cut down since they were in the middle or along the sides of the new roads. Other poles were used to create eagle mues.

The Eklutna power plant transmission line was an essential component to overall operations as the power delivery system to Anchorage. As such, it could be determined eligible for the National Register under criteria A and/or B - either independently or as part of a district encompassing the entire power project. The transmission line is not eligible under criteria C or D. Its construction, while certainly challenging, cannot be considered a significant engineering feat, or the embodiment of a distinctive type of construction. Nor does it contain information important to prehistory or history. It did not set a new standard for transmission line engineering or construction.

The transmission line may be eligible for the National Register as a site under criterion A. It is significant in local history because it was the first privately funded power plant in Anchorage. It served the city for over 25 years as the town grew from a budding railroad settlement into the largest Alaskan city. The Eklutna power plant represented local work, ingenuity and vision. It affected everyone in the Municipality through the provision of cheaper electricity. Finally, its construction was a symbol of permanence during a period of uncertainty.

The transmission line may also be eligible under criterion B through its association with Frank I. Reed. Reed is an important figure in the Anchorage's history. He was heavily involved and invested in the community both financially and personally. Reed arrived in Anchorage in 1915, just as the city was getting its start. He served on the first city council, instigated building a road out to Palmer, assisted the U.S. Army Signal Corps in finding a location for its new station in Anchorage, and (with his wife Pauline) ran a highly successful

hotel. “When he thought something should be done, he had the capacity to marshal resources and get it started.”¹⁴¹ Reed left an indelible imprint on the city through his power plant, hotel and other activities.

Consultation with Paul Lusigna, the National Park Service Keeper in Washington DC, concluded that the transmission line is not eligible for the National Register of Historic Places. The integrity of the line has been compromised as key sections of it are missing. The largest remaining continuous segment is a central piece of the line. This does not convey where transmission started or where it ended. Therefore, the overall significance of the transmission line has been compromised and it is not eligible as an independent property or as part of a district encompassing the entire power project. The powerhouse building is already listed on the National Register of Historic Places. It is beyond the scope of this report to determine the entire project's eligibility to the National Register as a district.

Though the transmission line is determined ineligible, it is unlikely that the remaining poles will be affected by military training activities in the near future. A significant portion of the transmission line has survived 60 years of military ownership largely intact. Where the line was destroyed, it was usually for early road building purposes at a time when the right-of-way still presented a visible and attractive cut through wilderness. Today, the right-of-way is obscured by new vegetation growth.

11.3 Areas for Further Study

One aspect of the power plant that was not examined in this report is the effect construction had on the Alaska Native population. The power plant was built in the heart of Eklutna, the largest Dena'ina settlement in the area. It altered Eklutna Lake, Eklutna River, and areas around these natural features.

Further, this report focuses on the period of development when Anchorage Light and Power owned the facilities. The city of Anchorage owned the Eklutna power plant from 1943 to 1953. Very few records were found to document this portion of the history, though a number of Anchorage residents were located who lived at or visited the Eklutna camp. Future studies may reveal more information regarding the power plant's operations from 1943 to 1955.

¹⁴¹ William and Lily Stolt, interviewed by Stephen Haycox & Maureen Cowles, Anchorage Pioneers Oral History Project, 9 Oct. 1992. UAA Archives p. 34.

REFERENCES

BOOKS

- Brabets, T. *Glacier Runoff and Sediment Transport and Deposition: Eklutna Lake Basin, Alaska*. Water Resources Investigations Report 92-4132. Anchorage, Alaska: United States Geological Survey.
- Carberry, M. and D. Lane. 1986. *Patterns of the Past: An Inventory of Anchorage's Historic Resources*. Municipality of Anchorage: Community Planning Department.
- Davis, N. 1984. *Energy / Alaska*. University of Alaska Press.
- Hollinger, K. 2001. *Homesteads on Fort Richardson, Alaska*. Colorado State University, Center for Ecological Management of Military Lands. U.S. Army Alaska, Fort Richardson.
- Pioneers of Alaska, Igloo 15, Auxillary 4. 1996. *Fond Memeories of Anchorage Pioneers*. Vol 1., pp. 186–187
- Routledge, G. 1985. *Alaska's Energy Resources*. Anchorage, Alaska: Wolfe Business Services.
- U.S. Army Alaska. 1985. *Installation Commander's Annual Real Property Utilization Survey, U.S. Army Alaska Volume 2 - Fort Richardson*. 1998.
- United States, Bureau of Reclamation. 1958. *Technical Record of Design and Construction: Eklutna Dam, Tunnel and Powerplant, Constructed 1951–1955, Eklutna Project Alaska*. Denver.
- United States, Bureau of Reclamation, Joseph M. Morgan. 1948. *Eklutna Project: To Serve 25% of all Alaskans*. Alaska Investigations Office.
- Whitehead, J. 1983. *Hydroelectric Power in the Twentieth Century Alaska: Anchorage, Juneau, Ketchikan and Sitka*. Bulletin of the Institute of Water Resources, Vol. 2. University of Alaska: Fairbanks.

NEWSPAPERS

- "Light and Power are Discussed," *Cook Inlet Pioneer*, 21 Aug. 1915.
- "Editorial," *Anchorage Daily Times*, 26 June 1928, p. 1.
- "Council Approves Power Line Lease," *Anchorage Daily Times*, 30 June 1928, p. 4.
- "Poles are Ready for Heavy Cable: Linemen at Work," *Anchorage Daily Times*, 27 June 1928.
- "Actual Construction Work on Eklutna Power Project Will Commence Next Week," *Anchorage Daily Times*, 11 Sept. 1928.
- "Eklutna Project Making Progress Along All Lines," *Anchorage Daily Times*, 9 Oct. 1928, p. 8.
- "More Men Added to Rush Work on Power Line," *Anchorage Daily Times*, 26 Oct. 1928, p. 6.
- "Poles are Ready for Heavy Cable: Linemen at Work," *Anchorage Daily Times*, 13 Nov. 1928, p. 4.

“Power Line is Completed; Work Starting on Tunnel at HydroElectric Camp,” *Anchorage Daily Times*, 3 Jan. 1929, p. 1.

“Witnesses Relate Details of Death, Eklutna Shooting,” *Anchorage Daily Times*, 28 March 1929, p. 4.

“Work at Eklutna Moving Steadily; Lake Dam Ready,” *Anchorage Daily Times*, 20 April 1929, p. 5.

“Power Tunnel is Near Completion; Finish Tomorrow,” *Anchorage Daily Times*, 20 June 1929, p. 4.

“City Council Lowers Rates Lights-Power,” *Anchorage Daily Times*, 25 July 1929, p. 1.

“Excursionists Inspect Great Power Project,” *Anchorage Daily Times*, 27 May 1929, p. 5.

“Myers Sentenced For Slaying Man at Eklutna Camp,” *Anchorage Daily Times*, 29 June 1929, p. 8.

“General Description of Project,” *Anchorage Daily Times*, 21 Sept. 1929, p. 15.

“Chance Launched Power Project: Success Achieved by Hard Work Backed by Faith in Enterprise,” *Anchorage Daily Times*, 21 Sept. 1929, p. 13

“Building of Transmission Line Established Records for Speed: Work Completed in 90 Days,” *Anchorage Daily Times*, 21 Sept. 1929, p. 10.

“Many Enjoy Trip to Eklutna Camp; See Power Plant,” *Anchorage Daily Times*, 23 Sept. 1929.

“Beloved City Power Facility was Stern Half of Tanker,” *Anchorage Daily Times*, 26 Jan. 1957, p. 11A.

“River Rehab: Village wants to removed junked cars and other trash and restore salmon runs,” *Anchorage Daily News*, 29 May 2001.

PERSONAL COLLECTION OF FRANK M. REED SR.

Company Correspondence

Russell-Colvin Company to Anchorage Light and Power. 25 June 1928.

Frank I. Reed to William Timson. 22 Oct. 1928.

Harold I. Wood, General Description of Power Project of the Anchorage Light and Power Co. 1929.

Joseph Shaw to Fred Tibbetts. 24 Sept. 1929.

Frank I. Reed to J.L. Dobbins of Russell-Colvin Co. 17 Feb. 1930.

Joseph Shaw to Anchorage Light and Power Company. 20 Oct. 1929.

Russell-Colvin Company to Frank I. Reed. 19 March 1930.

J.L. Dobbins to Frank I. Reed. 11 March 1930.

Frank I. Reed to J.L. Dobbins of Russell-Colvin Co. 30 May 1929.

Frank I. Reed to Pemberton & Vancouver Limited. 21 Dec. 1931.

Pemberton & Son Vancouver Limited to Frank I. Reed. 5 Dec. 1931.

Frank I. Reed to J.L. Dobbins of Russell-Colvin Co. 17 Feb. 1930.

Other

The Application of Frank I. Reed to Purchase Birch Timber. U.S. Land Office, Anchorage, Alaska. Serial No. 07431.

President's Annual Report. Anchorage Light & Power Company. 14 Oct. 1930.

President's Annual Report. Anchorage Light & Power Company. 1933.

MISCELLANEOUS

William and Lily Stolt, interviewed by Stephen Haycox & Maureen Cowles, *Anchorage Pioneers Oral History Project*, 9 Oct. 1992. UAA Archives. p. 34

Circular No. 164, Alaska Railroad Record, Vol. 1, No. 13.

Baird, S. 1993. *Energy Facts: Hydroelectric Power*. Originally Published by the Energy Educators of Ontario. <http://www.iclei.org/efacts/hydroele.htm>.

Eklutna Hydroelectric Project, Palmer, Alaska. U.S. Department of Energy, Alaska Power Administration.

Matanuska Electric Association's Pioneers, An History of Matanuska Electric Association. <http://www.matanuska.com/About/History2.html>

NATIONAL ARCHIVES - PACIFIC ALASKA REGION. Record Group No. 447, Alaska Power Administration. Box 42 of 67. Alaska District, Juneau. Historical Files and Photograph Collection 1948-1998. File: Fair Market Value and Severance Damages Applicable to HydroElectric Properties and Rights of City of Anchorage, Alaska (Federal Power Commission Licensed Project No. 350 Alaska - Eklutna) December 1952.

FRANK M. REED SR. PAPERS

UNIVERSITY OF ALASKA ANCHORAGE

MANUSCRIPTS AND RECORDS DEPARTMENT

Box 19, Series 7E, Folder 1

INTERVIEWS

Frank M. Reed, interviewed by William Gossweiler, Douglas Johnson and Russell Sackett, 29 Dec. 2000.

Frank M. Reed Sr., interviewed by Kristy Hollinger, 10 April 2001.

Frank M. Reed Sr., interviewed by Kristy Hollinger, 30 April 2001.

Frank M. Reed Sr., interviewed by Kristy Hollinger, 15 June 2001.

Frank M. Reed Sr., interviewed by Kristy Hollinger, 3 July 2001.

Frank M. Reed Sr., interviewed by Kristy Hollinger, 23 Aug. 2001.

Rae Kozlowski and Ken Hinchey, interviewed by Kristy Hollinger, 19 Sept. 2001.

Jane Lee, Pat Leddy and Mara Ada Peery, interviewed by Kristy Hollinger, 26 Sept. 2001.

Carmel Tysver, interviewed by Kristy Hollinger, 21 Sept. 2001.